



2015 BFS CATALOG

5 LINES OF QUALITY

MADE IN THE USA
EQUIPMENT
ACCESSORIES
SPEED
PLYOMETRICS
CLOTHING
PROGRAM
BARS
AND MORE!



DI



ABSOLUTE

VARSITY

ELITE

BXI

Free Shipping On Every Line Of BFS Equipment With a Qualifying Order!

See Page 1

DO YOU HAVE YOUR WRSC?

A Weight Room Safety Certification from BFS provides knowledge from strength and conditioning program info to safety protocols. BFS has the experience to help build and protect your championship program.



Sieze the Day in 2015 BFS Camps Clinics and Certifications come to you! - Pages 4-9



D1 Line - Built for the most demanding weight rooms

Highest quality line of equipment based on 3" x 3" steel and built for the highest profile institutions but affordable for any facility looking to be the best!

D1 Plus Line also available in heavier 7 gauge steel . Call for pricing

Elite Plus Line:

BFS has been manufacturing this line of 7 gauge steel equipment since the beginning and it is still unparalleled in the industry. Heavy weight and versatile, satisfied customers have installed 1,000s of Elite weight rooms.

Elite Line also available in lighter 11 gauge steel. Call for pricing.

Varsity Line:

BFS has the solution your customer needs. Big value for a small budget demands the high quality, no frills approach of this complete line of versatile weight room equipment.

Manufactured & Assy	Made in USA
Frame: Tubing Size	3" x 3"
Frame: Steel Gauge	11
Bar Catch & Safety Channel: Steel Gauge	7
Bar Catch & Safety Channel: # of slots	16 (Numbered)
Bar Catch & Safety Channel: Protection	Chrome
Bar Catch & Safety: Spacing	4"
Bar Catch & Safety: Manufacturing	Laser Cut for Precision
Plate Holders: Quantity	12
Plate Holders: Protection	12 Chromed with Rubber Bumpers
Chin up Bar	Multi Grip
Band Pegs	Removable
Bar Storage	4
Security	Bolt Down Tabs
Safety's: Length	24"
Safety's: Extension Steel Gauge	7
Platform: Tubing Size	2" x 3"

Expandable Features:

Maple Platform 2"x 3"	Yes
Dip Attachment	Yes
Landmine	Yes
Double Landmine	Yes
Swivel Handles	Yes
Rope Attachment (D-Clip)	Yes

Manufactured & Assy	Made in USA
Frame: Tubing Size	2" x 3"
Frame: Steel Gauge	7
Bar Catch & Safety Channel: Steel Gauge	7
Bar Catch & Safety Channel: # of Slots	14
Bar Catch & Safety Channel: Protection	Chrome
Bar Catch & Safety: Spacing	3"
Bar Catch & Safety Channel: Manufacturing	Laser Cut for Precision
Plate Holders: Quantity	12
Plate Holders: Protection	Chromed
Chin up Bar	Multi Grip
Bar Storage	2
Security	Bolt Down Tabs
Safety's: Length	22"
Safety's: Extension-Steel Gauge	7
Platform: Tubing Size	2" x 2"

Expandable Features:

Platform	Yes
Dip Attachment	Yes
Technique Attachment	Yes

D1 and D1 Plus Racks & Benches Ship Free With Orders over \$5000

Pages 10 through 17

Manufactured & Assy	Made in USA
Frame: Tubing Size	2" x 2"
Frame: Steel Gauge	11
Bar Catch & Safety Channel: Steel Gauge	11
Bar Catch & Safety: Spacing	4"
Plate Holders: Quantity	10
Chin up Bar	Straight
Security	Bolt Down Tabs
Safety's: Length	20"
Safety's: Extension - Steel Gauge	7
Platform: Tubing Size	2" x 1"

Expandable Features:

Platform	Yes
----------	-----

Elite Plus and Elite Racks & Benches Ship Free With Orders over \$4000

Pages 18 through 27

Varsity Racks, & Benches Ship Free With Orders over \$3000

Pages 28 through 33

Features common to all Lines

Vinyl – Marine grade, antifungal, antibacterial, mildew resistant, 29 oz., backed by 100% polyester stapled to ¾ plywood
 Pads - 2" thick, dense neoprene padding

attached to ¾ plywood
 Paint – Powder Coated, baked at 375 degrees
 Welds - .035 MIG welded
 Slides: Protection – Chromed

Lock Downs – 3/8 hardened pop pins
 Hardware – Zinc coated bolts with oversized washers with nylock nuts



Absolute Oval Line:

Completely new and rethought this line of equipment is perfect for the discerning, forward thinking client looking to differentiate themselves for the competition. Strong and stylish the Olympus line is a stand out.

Manufactured & Assy	Made in USA
Frame: Tubing Size	1 15/16" x 3 13/16"
Frame: Steel Gauge	11
Bar Catch & Safety Channel: Steel Gauge	7
Bar Catch & Safety Channel: Protection	Chrome
Bar Catch & Safety Channel: Spacing	6"
Plate Holders: Quantity	8
Plate Holders: Protection	Chromed
Chin up Bar	Multi Grip
Bar Storage	2
Security	Bolt Down Tabs
Safety's: Length	22"
Safety's: Extension - Steel Gauge	7
Platform: Tubing Size	1 15/16" x 3 13/16"
Expandable Features:	
Platform	Yes
Dip Attachment	Yes

All Specialty Racks & Benches Ship Free With Orders Over \$1000

Pages 34 through 37

All BXI and BXI Plus Racks & Equipment Ship Free With Orders Over \$2000

Pages 38 through 43

BFS Standards and Policies

BFS has standard policies that cover both the responsibilities and expectations of BFS and it's customers.

To review these policies in their entirety please visit www.biggerfasterstronger.com/ policies. If you would like a pdf of this docu-



BXI:

The evolving world of fitness demands new solutions and bold new ideas. The BXI modular approach is perfect answer to unconventional spaces from warehouses and industrial spaces to garages and basements.

BXI Plus Line also available in heavier 7 gauge steel . Call for pricing

Manufactured & Assy	Made in USA
Frame: Tubing Size	3" x 3"
Frame: Steel Gauge	11
Frame: Connectors	1" or 2" Pipe
Bar Catch & Safety Channel: Steel Gauge	7
Bar Catch & Safety: Spacing	2"
Plate Holders:	12
Chin up Bar	Straight
Bar Storage	2
Security	Bolt Down Tabs
Safety's: Length	24"
Safety's: Extension: Steel Gauge	7
Platform: Tubing Size	2" x 3"
Expandable Features:	
Platform	Yes
Dip Attachment	Yes
Landmine	Yes
Double Landmine	Yes
Rope Attachment (D-Clip)	Yes
Wall Ball Target	Yes
Step Up Platform	Yes
Multi-Purpose Bracket (Heavy bag Holder, etc...)	Yes
Plate Storage Peg	Yes

All Absolute Oval Racks & Benches Ship Free With Orders Over \$4000

Pages 44 through 49

Our Warranty

Frame & Welds: Lifetime
Flange Bearings, Pulleys, and Guide Rods:



Custom Options at No Extra Cost

Customize your colors on all BFS manufactured steel equipment

Frame Color

Steel is available in tough and durable Black, White, Gray, or Red powder coat paint.



Upholstery Color

2. 29 oz. vinyl backed by 100% polyester and 3/4" plywood. Vinyl Upholstery is available in Gray, Blue, Green, Red or Black. More colors are available for custom orders



Don't see what you want? Call a BFS equipment expert to discuss customizing your order further.

Shipping

Custom Equipment

Most BFS steel equipment is custom manufactured and usually ships in 4 to 6 weeks

Stock Equipment

Need a Quick Turnaround so you can get your equipment now? BFS keeps the black paint and gray vinyl* option on hand in order to ship quickly, usually within 48 hours.

*To achieve quick shipping high wear black neoprene rollers are installed on all orders with the Black Paint / Gray Upholstery color combination.

BFS INNOVATION

Every Piece of BFS Manufactured Steel Equipment is Crafted With Exceptional Features. Here in the USA!

5 years









Linear Bearings and Cables: 1 year
Upholstery, Grips, and Custom logos: 120 days

Other BFS products carry a one-year warranty against manufacturer's defects



BIGGER FASTER STRONGER

EQUIPMENT • TRAINING PROGRAMS • CHARACTER

 BFS Services	3	 Hydraulic Equipment	73
Weight Room Design	3	 Weight Room Storage	75
Camps and Clinics	4	 Bars and Collars	77
WRSC Certification	8	 Plates Bumpers Dumbbells	82
 D1 Line	10	 Flooring	84
D1 Racks and Platforms	11	 Cardio	86
D1 Benches and Auxiliaries	16	 Speed and Plyo	89
 Elite Line	18	 Accessories	95
Elite Racks and Platforms	19	 Clothing	101
Elite Benches	25	 Packages	101
 Varsity Line	28	 Instructional Materials	103
Varsity Racks and Platforms	29		
Varsity Benches	33		
 Specialty Racks & Benches	34		
 BXI Series	38		
BXI Rigs	39		
BXI Racks & Auxiliaries	42		
 Absolute Line	44		
Absolute Racks	45		
Absolute Benches & Auxiliaries	47		
 Plate Loaded Equipment	50		
Plate Loaded Upper Body	50		
Plate Loaded Lower Body	57		
Selector Equipment	62		
Selector Line Upper Body	62		
Selector Line Lower Body	69		
Selector Circuit	71		
2 in 1 Selector Line	72		



**EXPANDED and NEW PRODUCT LINES
- ONLINE
www.biggerfasterstronger.com**

Nutrition

NCAA Compliant protein from MANFEED PRO. All Natural and highly digestible MANFEED PRO, created by GreenLife, Labs, is the safe and effective supplement for increasing weight, strength and power!

Clothing

Training to Game day - Athletes to Coaches get fit and get fitted out with the all new BFS Clothing Line.

With a full line of shirts and shorts in performance materials you will find the gear to help you achieve your goals in comfort and style. For Coaches we have kahkis, polos and jackets to keep you steaming towards victory. From Golf to Football to Track - BFS is your solution to training in comfort so you can concentrate on results.

Computer Aided Coaching

Whether you are looking for video analysis or an electronic solution to record keeping and weight room motivation we have it with the industry leading Beat the Computer training program and the Quicksout analysis tool

* Plates, Bars & all Accessories in photos are not included

BIGGER FASTER STRONGER INC. 2930 West Directors Row Salt Lake City, Utah 84104 • info@bfsmail.com

More information: www.biggerfasterstronger.com/policies

Pricing Policy Payment Methods Sales Tax
Shipping Back Orders Return Policy
Cancellation Policies Damaged Items Warranty
Recommended Maintenance Before Using BFS Equipment Privacy Policy

PROUD TO BE A LONG TIME SUPPLIER OF US GOVERNMENT FACILITIES

Camp Pendleton	Fort Bragg	Center	DEA
US Army	Naval Academy	US Marshals	US Air Force ...
Rangers P.B.O	US Marines	US Dept of	And many more
NASA	Naval Training	Justice	

CONCEPT TO COMPLETION™

SUPERIOR WEIGHT ROOMS = ATHLETIC DOMINANCE



For over 30 years BFS has been providing middle schools, junior high schools and senior high schools with the tools they need for success. We'd like to do the same for your school. We are

your full-service company for not only all your Exercise Equipment needs, but for safe and effective Exercise Instruction and Program Design.

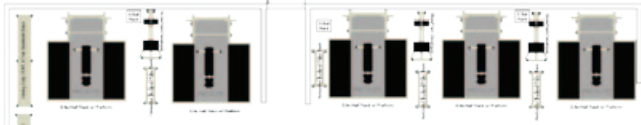
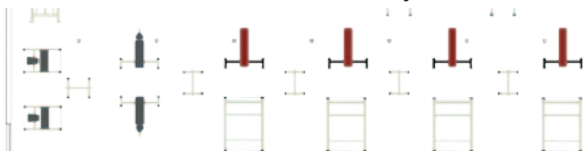

1 The 2D illustration is the first step of the Concept to Completion process. These illustrations are drawn to scale to

show you exactly how your weight room can be laid out, thereby ensuring proper use of available space and the

best design for safety and traffic flow.



2 In addition to 2D illustrations, BFS can also provide you with 3D illustrations. These 3D renderings are drawn to scale to show you exactly how your weight room

can look, ensuring proper use of available space and the best design for safe traffic flow. Having a 3D illustration is also a great way to help generate funding for

a new facility. (BFS must complete a 2D illustration of your facility prior to the 3D illustration)

3D Illustration \$250

Fee waived upon order of \$3000 or more - Item #325095



Ask about installation services!

3 BFS provides unmatched, ongoing support. With instructional clinics in

safety and technique as well as coaches' certification courses, BFS provides all

the tools for raising your program to THE NEXT LEVEL!

BFS STEP UP TO SUCCESS PROGRAM

BUILDING A GREAT WEIGHT ROOM - ONE STEP AT A TIME, ALL ON YOUR 3 TO 5 YEAR TIME LINE

Although it's great to get the funding to build a new weight room, as we say, "From Concept to Completion," the reality is that many schools have limited budgets. The alternative is not to give up on your dream, but to take the process one step at a time.

planning BFS can help by providing you with a safety evaluation and needs analysis. From there we will help you establish an annual budget and then show the process, step-by-step, with 2-D and 3-D image rendering technology.

could replace bent barbells with high-quality multi-purpose bars, and your solid steel weight plates with bumpers. The next year, replace worn-out benches and flooring. The following year start adding racks. Before you know it, your dream weight room will become a reality!

Throughout this process of long-term

As an example, during the 1st year you

CALL BFS AND TALK TO ONE OF OUR SALES STAFF TO GET STARTED

www.biggerfasterstronger.com • 1-800-628-9737 • Fax 1-801-975-1159

TOTAL PROGRAM CLINICS & CHAMPIONSHIP CAMPS



Bring BFS into your School

Exercise Instruction
Character Education
Coaches Sessions
Weight Room Safety
Weight Training,
Weight Room
Evaluation



BFS PRESENTATIONS IN 4 FORMATS COMBINE FOR

A BFS Championship Camp & Coaches WRSC

2 Days, 50 Athletes & 5 Coaches: \$6980
Product # 800A

Be an 11 Seminar • 2 Day Total Program Clinic • In-Service Weight Room Safety Certification

Pricing and Savings

Includes Travel, Air Fare and Expenses

Retail: 50 Students & 5 Coaches	Package
Be An 11 \$2990	\$1495
2 Day TPC \$3990	\$3990
In-Service WRSC \$3195	\$1495
Implementation Package \$3500	\$0
Total : \$13,675	\$6980

Save Over \$6695!

WRSC: \$299 per coach over 5
Camp: \$40 per student over 50

Implementation package

Valued at over \$3,500 the implementation package contains equipment, instructional materials and ongoing support to allow you to take charge of your program immediately after the conclusion of your Championship Camp!

Includes:
Complete Weight Room Evaluation and 2D weight room layout design, Set Rep Logs, Youth Training Bar Package, Total Program DVDs, Be An 11 books, camp t-shirts, 4 month magazine subscription for all athletes and students attending, WRSC Support for certified coaches and much, much more!

Experience, Tradition, and Value:

The BFS Championship Camp delivers a winning culture to your school - in athletics and in life!

B BFS Championship Camp 2 Days, 50 Athletes \$5485

Product # 800B

Be an 11 Seminar • 2 Day Total Program Clinic

Pricing and Savings

Includes Travel, Air Fare and Expenses

Retail Price: 50 Students	Package
Be an 11 Seminar \$2990	\$1495
2 Day TPC \$3990	\$3990
Implementation Package \$2500	\$0
Total: \$9480	\$5485

Save Over \$3995!

Camp: \$40 per student over 50

Implementation package valued at over \$2,500. Includes Set Rep Logs, Weight Room Evaluation, Total Program DVDs, Be An 11 books, camp t-shirts and much more!

G Be An 11, Coaches WRSC 50 Athletes & 5 Coaches:

\$4735 Product # 800G

Pricing and Savings

Includes Travel, Air Fare and Expenses

Retail: 50 Students & 5 Coaches	Package
Be an 11 Seminar \$2990	\$2990
In-Service WRSC \$3195	\$1745
Implementation Package \$2500	\$0
Total: \$8685	\$4735

Save Over \$3950!

Be An 11: \$30 Per student over 50
WRSC: \$349 per coach over 5

C Be An 11, Coaches WRSC 1 Day Total Program Clinic,

50 Athletes & 5 Coaches: \$6480 Product # 800C

Pricing and Savings

Includes Travel, Air Fare and Expenses

Retail: 50 Students & 5 Coaches	Package
Be an 11 Seminar \$2990	\$1495
1 Day TPC \$3490	\$3490
In-Service Cert. \$3195	\$1495
Implementation Package \$3000	\$0
Total: \$12,675	\$6480

Save Over \$6195!

Be An 11: \$20 per student over 50
1 Day Clinic: \$20 per student over 50
WRSC: \$299 per coach over 5

Implementation package valued at over \$3,000. Includes Set Rep Logs, equipment, Total Program DVDs, Be An 11 books, WRSC Support and much more!

H Coaches Weight Room Safety Certification

10 Coaches Minimum
\$5190 Product # 800H

Pricing

Includes Travel, Air Fare and Expenses

10 Coaches
10 Coaches x \$399 - \$3990 + 1200 deposit
Total: \$5190

WRSC: \$399 per coach over 10
Implementation package worth over \$2,300.

START YOUR CHAMPIONSHIP JOURNEY HERE!

Four Building Blocks are the Foundation of the BFS Camps Clinics and Certification program.

With two flavors of the **Total Program Clinic**, the character education benefits of the **Be An 11 Seminar**, and the Strength, Conditioning and Safety instruction of the **WRSC** you can find the combination that your program needs!

2 Day Total Program Clinic: Up to 12 hours of hands on Strength & Conditioning Training for Athletes & Coaches, Core Lifts, Auxiliary Lifts, Speed, Plyometrics, Flexibility, Nutrition, Program, etc... Coaches only break out session starts off the clinic to ensure you are able to immediately put the Total Program in use for your team. In a 2 Day Clinic, a BFS clinician will show you how to unify your athletic program to ensure athletes will progress, year-round. The two-day clinic permits more hands-on instruction and additional time for our clinicians to answer your questions to make this a more complete, personalized experience.

1 Day Total Program Clinic: Up to 6 hours of Hands on Strength & Conditioning Training for Athletes & Coaches, Core Lifts, Auxiliary Lifts, Speed, Plyometrics, Flexibility, Nutrition,

Program, etc... Coaches only break out session starts off the clinic

Be An 11: Up to 3 hours of Character Education, Goal Setting, Team Building Activities, Championship Attitude Activities, Community Support, Unification, etc... Learn how a Be An 11 seminar can inspire your teams and student body, Call your BFS coach 800-628-9737!

WRSC: (In-Service or Regional Certifications Available) A BFS Weight Room Safety Certification provides a minimum of 8 hours of Hands on Teaching Protocols, Program Implementation Details, Safety & Liability Details, Weight Room Evaluation, Core Lifts, Auxiliary Lifts, etc... WRSC includes one year of online video training support.

11 OPTIONS TO COVER YOUR UNIQUE SITUATION

D Be An 11 Seminar,
1 Day Total Program Clinic

50 Athletes: \$4985
Product # 800D

Pricing and Savings

Includes Travel, Air Fare and Expenses

	Retail Price: 50 Students	Package
Be an 11 Seminar	\$2990	\$1495
1 Day TPC	\$3490	\$3490
Implementation Package	\$2500	\$0
Total	\$8980	\$4985

Save Over \$3995

Be An 11: \$20 per student over 50
1 Day Clinic: \$20 per student over 50

Implementation package valued at over \$2,500. Includes Set Rep Logs, equipment, Total Program DVDs, Be An 11 books, and much more!

I 2 Day Total Program Clinic,
50 Athletes \$3990
Product # 800I

Pricing Includes Travel, Air Fare and Expenses

2 Day Clinic: \$30 per student over 50
Implementation package worth over \$1,500.

E 2 Day Total Program Clinic,
Coaches WRSC

50 Athletes & 5 Coaches: \$5735 Product # 800E

Pricing and Savings

Includes Travel, Air Fare and Expenses

	Retail Price: 50 Students	Package
2 Day TPC	\$3990	\$3990
In-Service Cert.	\$3195	\$1745
Implementation Package	\$2500	\$0
Total:	\$9685	\$5735

Save Over \$3,950!

2 Day Clinic: \$30 per student over 50
WRSC: \$349 per coach over 5

Implementation package valued at over \$2,500. Includes Set Rep Logs, equipment, Total Program DVDs, WRSC Support and much more!

J 1 Day Total Program Clinic,
50 Athletes \$3490
Product # 800J

Pricing Includes Travel, Air Fare and Expenses

1 Day Clinic: \$30 per student over 50
Implementation package worth over \$1,500.

F 1 Day Total Program Clinic,
Coaches WRSC

50 Athletes & 5 Coaches: \$5235 Product # 800F

Pricing and Savings

Includes Travel, Air Fare and Expenses

	Retail Price	Package
1 Day TPC	\$3490	\$3490
In-Service Cert.	\$3195	\$1745
Implementation Package	\$2500	\$0
Total:	\$9185	\$5235

Save Over \$3,950!

1 Day Clinic: \$30 per student over 50

WRSC: \$349 per coach over 5
Implementation package valued at over \$2,500. Includes Set Rep Logs, equipment, Total Program DVDs, WRSC Support and much more!

K Be An 11 Seminar
50 Athletes \$2,990
Product # 800K

Pricing Includes Travel, Air Fare and Expenses

Be An 11: \$30 per student over 50
Implementation package worth over \$1,000.

Package Details and Information: All camps and clinics offered come with implementation packages containing instructional materials, many worth more than \$3,000. For complete details on these packages and what you can expect from your camp, clinic or seminar visit www.biggerfasterstronger.com/camps. Here you will also find helpful hints and instructions on what you can do to prepare for your BFS clinics. All dates must be booked 30 days prior to clinic date. **Book early to lock in your preferred dates.**

Questions? Don't hesitate to call BFS at 800-628-9737 to learn more about all the services offered by Bigger Faster Stronger. BFS is Coaches Helping Coaches and we are committed to taking your program in fitness, athletics and physical education to the next level!

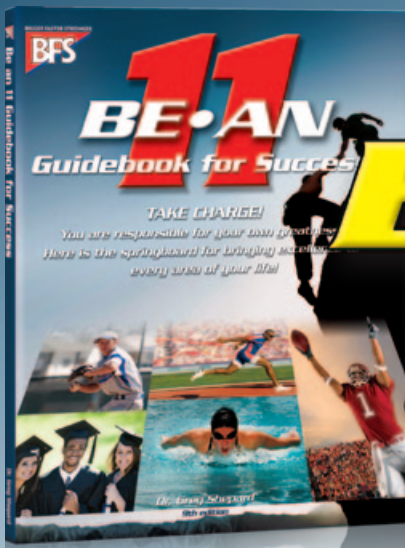

BE AN 11 Seminars



**“Be An 11 has changed my life!
I WILL BE AN 11!”**

- Katie Heinlen



“The most inspiring night of my life!”

Kyle Meyers,
Rutherford B. Hayes High, OH

“Reaffirmed the reason I entered coaching 25 years ago.”

Coach Al McFarland

“This is exactly what our school and community - needed.”

Coach Fox



**“Every school in the nation should schedule a Be An 11 Seminar today!
It is without a doubt the best thing that has happened to our school.”**

Coach T. Cox

BE AN 11 SEMINAR HERE'S HOW IT WORKS:

- ▶ A BFS Presenter will come to your school and will spend up to three hours inspiring, motivating and educating your athletes how to become true elevens!
- ▶ The cost is only \$2,990 for 50 athletes. Additional athletes only

\$30 each. Includes the Be an 11 Guidebook!

- ▶ All travel fees included in price. No hidden fees!
- ▶ Book your dates now! First come - First Serve.

INTERESTED SCHOOLS CAN REQUEST A FREE BE AN 11 BOOK & SEMINAR LITERATURE

- ▶ Christian B11 Seminar is also available
CALL FOR DETAILS

- ▶ Package your Be An 11 Seminar with a Total Program Clinic or a BFS Weight Room Safety Certification (WRSC) and save while bringing the BFS program to your school. See the inside front cover of this magazine to learn about how to bundle and save on BFS camps and clinics!

Great Results!

"BFS is the key to a winning program. For over ten years, I have brought BFS in to do clinics, and they are incredible. The clinicians are professional, open to questions, knowledgeable, and I have never been disappointed with their presentations. I have brought BFS in to 3 different high schools and have learned something every year.

I really believe in BFS and the success they can bring to any program."

Ron Hamamoto
Monte Vista High School
San Diego, California

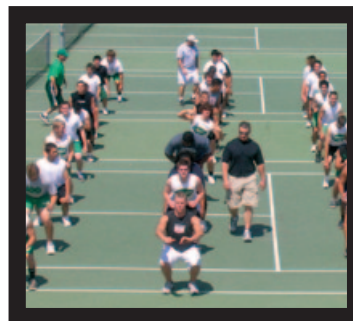

**ACHIEVE
YOUR GOALS!**



PROGRAM CLINIC

1 and 2 Day Total Program Clinics teach:

The BFS Total Program

Off-Season Program

The 6 Absolutes of Perfect Technique

Dot Drill

Box Squat, Towel Bench,

Hex Bar Deadlift

Nutrition

Team Building • Goal Setting

Parallel Squat, Bench Press, Power Clean

Total Program Workout

Auxiliary Lifts

In-Season Program

Weight Room Safety

1-2-3-4 Flexibility Program

Sprint Technique

Plyometric Box Jumping

**THE
TOTAL
PROGRAM**

SUCCESS AND THE TOTAL PROGRAM

Unify Your Sports and Athletic Programs to Win!

A BFS instructor will come to your school and show you how to unify your athletic program to ensure athletes will progress, year-round. With athletes hands-on instruction and pre clinic coaches only session the TPC is the winning edge!

Athletics can be a huge part of a student's development. The BFS Total Program is a complete system that can unify schools's athletic and PE programs.

THE PROGRAM

The BFS Total Program is a strength and conditioning program that helps athletes reach their full potential. Confidence and leadership is built through the process of consistently breaking personal records and achieving goals.

It is not a fad or a short cut, the Total Program is a time tested regimen that requires discipline and hard work. These qualities make it a great system for team building, offering opportunities for students to help and encourage each other.

For over 35 years coaches and administrators have found the Total Program to be highly efficient and remarkably effective within the confines of student's busy

schedules. Utilizing the Total Program across all sports and in PE classes both coaches and athletes have a framework for improvement. We call this Unification. When an entire athletic department and PE curriculum are on the same page the results are amazing!

SAFETY

BFS understands that safety is priority one with your athletes. At a Total Program Clinic BFS spends as much time on proper weight room behavior and spotting as on perfect lifting technique. By emphasizing the proper safety protocols and the perfect lifting technique we are building not only strength but responsibility and accountability.

SUCCESS

When you bring in the BFS Total Program you are bringing in a proven road map to success.

BFS is committed to building winning programs and we have the track record to back this up. The majority of schools that host a Total Program Clinic improve their win loss record immediately! More state championships have been won using the BFS Total Program than any other strength and conditioning program in the country.

PRESENTATION DETAILS:

2 Day TPC, Up to 12 hours of Hands on Strength & Conditioning Training for Athletes & Coaches

2 Hour Coaches Clinic is part of the TPC: Teaching Protocols, Program Implementation Details, Safety & Liability Details

Implementation Each Athlete will receive a Clinic Packet of Materials

2 Day TPC - 50 Athletes \$3990 Includes Travel, Air Fare and Expenses

\$30 per student over 50

Implementation package worth over \$1,500.

1 day option available - Package with other BFS presentations and save hundreds of dollars



2015 WEIGHT ROOM SAFETY CERTIFICATION

Cert. Date	Location	City	ST
10/18/14	MAHPERD	Timonium	MD
11/19/14	NYSAPERD	Verona	NY
1/9/15	Slam Charter HS	Miami	FL
1/17/15	St. Olaf College	Northfield	MN
1/17/15	Bryant HS	Bryant	AR
1/24/15	Skyline HS	SLC	UT
1/24/15	SUNY Cortland	Cortland	NY
1/31/15	Monte Vista HS	Spring Valley	CA
2/7/15	BFS Science Lab	Mahopoc	NY
2/9/15	Montgomery City HS	Mont. City	MO

Cert. Date	Location	City	ST
2/21/15	Dulaney HS	Timonium	MD
2/21/15	Sycamore HS	Cincinnati	OH
2/21/15	St. Marys HS	Medford	OR
3/21/15	Manchester HS	Manchester	MI
3/21/15	Selah HS	Selah	WA
4/25/15	Beverly HS	Beverly	MA
5/9/15	BFS Science Lab	Mahopoc	NY
5/16/15	Ripon College	Ripon	WI
5/30/15	Ferris HS	Ferris	TX
6/10/15	Knox College	Galesburg	IL

- Improve Weight Room Safety
- Perfect Your Technique

- Learn Proper Spotting
- Understand Liability

- Protect Your Athletes
- Protect Your Coaches

REDUCE LIABILITY WITH CERTIFIED COACHES AND TEACHERS

Join coaches in your area to learn how best to train your students and athletes with the proven BFS program. Not only will this BFS Weight Room Safety Certification (WRSC) ensure that you know how to improve athletic performance, you will learn techniques to significantly improve the safety of training for every sports program and PE class.

This is a hands-on, learn-by-doing certification

Visit www.biggerfasterstronger.com to register

\$299 per coach with early registration

\$399 regular price within 30 days of certification

Keep up with NEW or UPDATED events with the online calendar page

Practical & Theory Course - 1 Day, Hands on Practicum & Online Exam.

WRSC includes continuing education through one year of online video training through the BFS Online Learning Center as well as one year of the BFS Magazine and the "What's Happening" Email

100's CERTIFIED EVERY YEAR!

"We just clinched the league title with one more regular season game left until playoffs. First time North has won league Championship since 1973. Your program along with the clinic has definitely changed the attitude and helped my football program. Other sports are coming to me asking me about the BFS program after seeing our success."

Joseph Trongone, Head Coach, North High School



YEAR ROUND SUPPORT

**STREAMING DEMONSTRATION VIDEOS • MAGAZINE SUBSCRIPTION
POSITION PAPERS • INSPIRATIONAL AND MOTIVATIONAL TECHNIQUES
REGULAR UPDATES • SETS AND REPS RECORD KEEPING**

Look at who, where, and why America's teachers and coaches are becoming Weight Room Strength and Conditioning Coaches by achieving the BFS "Weight Room & Safety Certification (WRSC).

Should Teachers or School Corporations take the risk of supervising students in weight rooms without a proper Strength and Conditioning Certification that is designed to deal with the potential dangers surrounding the weight room? The completion of a "WRSC" prepares teachers, trainers, and coaches to deal with critical issues involving weight room Strength and conditioning. The BFS Weight Room & Safety Certification (WRSC) is proof of competence, experience, and the qualifications needed to organize, instruct and supervise students in free weight lifting, spotting, and postural issues. WRSC also covers developing program, proper poundage progression, student record keeping, speed and power development, flexibility, and issues that deal with potential weight room litigation.

School corporation administrators, dept heads, and athletic directors can potentially benefit as well, from supporting and encouraging their teachers working in the weight room to achieve the "WRSC" credential.

Together we can make America's weight rooms safer for students, more productive, and help teach students some of the workout skills needed for lifelong health and wellness.

Once certified maintaining all the benefits of being a WRSC Coach is easily maintained through \$99.95 yearly renewal fee. This will keep all the online benefits including video instruction available for incoming athletes and assistants as well as the BFS Magazine to keep up to date on the latest in safety and reducing liability concerns.



EXCLUSIVE ONLINE SUPPORT • EMAIL BULLETINS • MAGAZINE

www.biggerfasterstronger.com • 1-800-628-9737 • Fax 1-801-975-1159

BFS



#21 Marcus Lattimore
Heisman Trophy Candidate
University of South Carolina
p26



D1 Line

BFS is producing the finest weight room equipment available. With the D1 line our exceptional value for dollar is increased. D1 is made for the most demanding, high profile programs. Built in the USA with 3" by 3", 11 gauge steel tubing and chromed and laser cut guides D1 racks, platforms and benches are a must see addition to the BFS universe!

D1 Plus line also available in heavier 7 gauge steel - Call for pricing

The premier line of equipment from BFS is available with Free Shipping on qualifying orders over \$5,000. Save \$100s even \$1,000 on your weight room.

To take advantage of this incredible offer call a BFS coach at 800-628-9737



The ultimate in team pride!

Custom nameplate cut from 7 gauge steel
5 or more only \$199 each

#501RKLB

**All D1 and D1 Plus Racks & Benches
Ship Free With Orders over \$5000**

Pages 10 through 17

D1 Half Rack

Custom Colors See Page 1!
3" x 3" 11-gauge steel construction.

\$2495
5D197
l-57" w-66" h-104"

Standard Features



7-gauge chrome-plated adjustment system with laser cut numbering



4 upright Olympic bar holders



Chrome-plated Olympic plate size horns angled for safety



Bench Docking System for use with Bench #5D107



Multi-grip pull-up bar



Multiple pegs on each side for band resistance exercise

Custom Logo Available
\$299 Call BFS
New Item!

Double Landmine
\$225
#5D1DLM

Package Options



A Swivle Handle Chin Up Option:
\$145
#5D1SW



B Dip Attachment:
\$225
#5D118

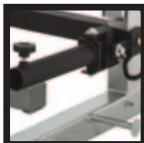

C Land mine option for fulcrum lifts:
\$195
#5D1LM



D D1 Bench with docking system **\$605**
#5D107



E D Clip **\$165**
#5D1RADC

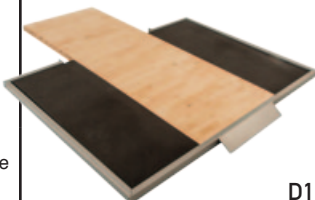

F Modular Power Clean Platform:
\$1695
#6D154HR



Optional Bench Shown

MADE IN THE USA

D1 Half Rack Total Package

Package includes rack and options:
1 x A, 1 x B, 1 x C, 1 x D, 1 x E **\$3265**
#6D197TP

Save \$565
Off Retail

D1 Half Rack Total Package with Wood Platform

Package includes rack and options:
1 x A, 1 x B, 1 x C, 1 x D, 1 x E, 1 x F **\$4810**
#6D197TP1

Save \$715
Off Retail

D1 Half Rack with Wood Platform

Package includes rack and options:
1 x F **\$3790**
#6D197P1

Save \$400
Off Retail

D1 Racks and Platforms

D1 Full Cage

Custom Colors See Page 1!
3" x 3" 11-gauge steel construction.

\$2795

5D196
l-80" w-66" h-104"

Standard Features



7-gauge chrome-plated adjustment system with laser cut numbering



4 upright Olympic bar holders



Chrome-plated Olympic plate size horns angled for safety



Bench Docking System for use with Bench #5D107



Multi-grip pull-up bar



Multiple pegs on each side for band resistance exercise

Custom Logo Available
\$299 Call BFS

New Item!
Double Landmine
\$225
#5D1DLM

Package Options



A Swivle Handle Chin Up
#5D1SW
\$145



B Dip Attachment:
#5D118
\$225



C Land mine for fulcrum lifts:
#5D1LM
\$195



D D1 Bench with docking system
#5D107
\$605



E D Clip
#5D1RADC
\$165



G Modular Power Clean Platform:
#6D154FC
\$1745

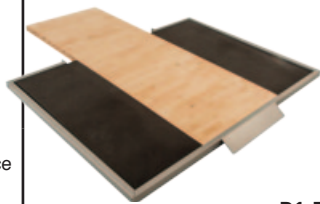

D1 Full Cage Total Package

Package includes rack and options:
1 x A, 1 x B, 1 x C, 1 x D, 1 x E

\$3515
#6D196TP

Save \$615
Off Retail

D1 Full Cage Total Package with Wood Platform

Package includes rack and options:
1 x A, 1 x B, 1 x C, 1 x D, 1 x E, 1 x G

\$5110
6D196TP1

Save \$765
Off Retail

D1 Full Cage with Wood Platform

Package includes rack and options:
1 x G

\$4,090
#6D196P1

Save \$450
Off Retail

D1 Double Sided Half Rack

Custom Colors See Page 1!
3" x 3" 11-gauge steel construction.

\$3595

5D198
1-99" w-90" h-104"



MADE IN THE USA



D1 Double Sided Half Rack Total Package (No Platforms)

Package includes rack and options:
2 x A, 2 x B, 2 x C, 2 x D, 2 x E

\$5235
#6D198TP

Save \$1030
Off Retail

D1 Double Sided Half Rack Total Package with 1 Wood Platform

Package includes rack and options:
2 x A, 2 x B, 2 x C, 2 x D, 2 x E, 1 x F

\$6780
#6D198TP1

Save \$1180
Off Retail

D1 Double Sided Half Rack Total Package with 2 Wood Platforms

Package includes rack and options:
2 x A, 2 x B, 2 x C, 2 x D, 2 x E, 2 x F

\$8325
#6D198TP2

Save \$1330
Off Retail

D1 Double Sided Half Rack with 1 Wood Platform

Package includes rack and option:
1 x F

\$4790
#6D198P1

Save \$500
Off Retail

D1 Double Sided Half Rack with 2 Wood Platforms

Package includes rack and option:
2 x F

\$6285
#6D198P2

Save \$700
Off Retail

D1 Racks and Platforms

D1 Multi-Use Rack

Custom Colors See Page 1!

3" x 3" 11-gauge steel construction.

\$3195

5D199

l-99" w-90" h-104"

Standard Features



7-gauge chrome-plated adjustment system with laser cut numbering



4 upright Olympic bar holders



Chrome-plated Olympic plate size horns angled for safety



Bench Docking System for use with Bench #5D107



Multi-grip pull-up bar



Multiple pegs on each side for band resistance exercise

Custom Logo Available \$299 Call BFS

New Item!

Double Landmine \$225

#5D1DLM

Package Options



A Swivle Handle Chin Up

Up

\$145

#5D1SW



B Dip Attachment:

\$225

#5D118



C Land mine for fulcrum lifts:

\$195

#5D1LM



D D1 Bench with docking system

\$605

#5D107



E D Clip

\$165

#5D1RADC

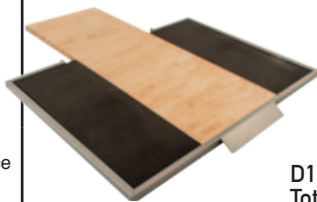

H Modular Power Clean Platform:

\$1795

#6D154MU



D1 Multi-Use Rack Total Package

Package includes rack and options:
1 x A, 1 x B, 1 x C, 1 x D, 1 x E

\$3865

#6D199TP

Save \$665

Off Retail

D1 Multi-Use Rack Total Package with Wood Platform

Package includes rack and options:
1 x A, 1 x B, 1 x C, 1 x D, 1 x E, 1 x H

\$5510

#6D199TP1

Save \$815

Off Retail

D1 Multi-Use Rack with Wood Platform

Package includes rack and option:
1 x H

\$4490

#6D199P1

Save \$500

Off Retail

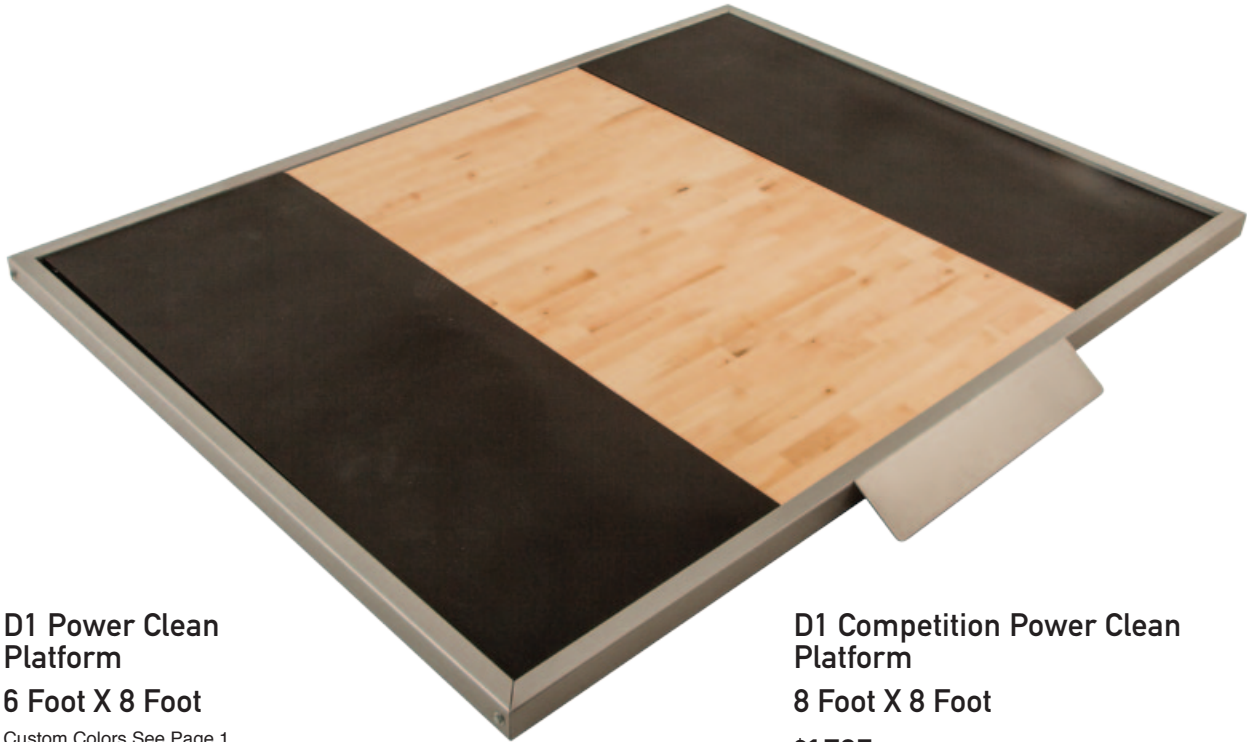

D1 Power Clean Platform

6 Foot X 8 Foot

Custom Colors See Page 1

Custom Logo Available \$299 Call BFS

\$1595

#6D15468
l-76" w-100" h-3"

D1 Competition Power Clean Platform

8 Foot X 8 Foot

\$1795

#6D15488



D1 Power Clean Insert Platform

Available as a modular insert for the D1 Half Racks and D1 Full Cage and Multi Use Rack See pages 11, 12, 13 and 14 for details

Custom Logo Available \$299 Call BFS

Half Rack Insert

\$1695

#6D154HR

Full Cage Insert

\$1745

#6D154FC

Multi Use Insert

\$1795

#6D154MU





**D1
Flat to Incline Bench**

Custom Colors See Page 1!
Adjusts from flat to military positions.
0°, 30°, 35°, 45°, 80°
Handle and wheels for easy mobility

Without Spotter Stand

\$605

#5D107
l-51" w-30" h-18"

**D1
Flat to Incline Bench
Spotter Stand**

\$195

#5D113
l-51" w-30" h-18"



Custom Sweat Guards
3 or More Only

\$179 Each

#504SGL3



**D1
Multi Angle Bench**

Custom Colors See Page 1!
Adjusts from flat to military positions.
-20°, 0°, 30°, 35°, 80°
Handle and wheels for easy mobility

\$735

#5D114
l-51" w-30" h-18"



Docking mechanism



D1 Olympic Bench

Custom Colors See Page 1!
Most heavy duty bench sold anywhere
Massive 3"x3" 11-gauge steel construction
Lifetime frame warranty
Extra durable high-density pad & upholstery

\$655

#5D101
l-60" w-49" h-52"



D1 Glute/Ham Developer

Custom Colors See Page 1!
Heaviest-duty glute-ham developer
Built to accommodate even the largest athletes
Strong and smooth vertical and horizontal slides
Dual adjustable ankle pads for secure fit
Extra large, high-density split thigh pad for maximum comfort

\$995

#5D130
l-62" w-31" h-53"



BFS

Elena
Delle Donne
WNBA
Chicago
Sky p 44



Elite Plus Line

BFS Elite Plus racks, platforms and benches, built with 2" x 3" 7 gauge steel, are the foundation for countless championship quality weight rooms. Weight training is the basis for any athletic endeavor. Whether it is basketball, football, soccer, track or volleyball the Elite Plus line from BFS is the straightest path to stronger and more athletic teams.

Elite line also available in lighter 11 gauge steel - Call for pricing

For complete Weight Rooms BFS offers substantial discounts and our trained staff can find you the best possible savings. Give us a call with and ask for a price quote on package deals!



The ultimate in team pride!

Custom nameplate cut from 7 gauge steel
5 or more only \$199 each

#501RKLB

**All Elite Plus and Elite Racks & Benches
Ship Free With Orders over \$4000**

Pages 18 through 27

for Athletes p 26

Training p 34



Elite Plus Half Rack

Custom Colors See Page 1!
 2" x 3" 7 Gauge Steel Construction
BUILT TO LAST:
 Lifetime frame warranty

\$1,995
 #5EP97
 L-44" w-64" h-95"

Standard Features



7-gauge chrome-plated bar catch adjustment rails



2 upright Olympic bar holders

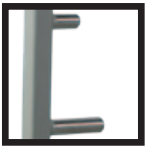

Chrome-plated Olympic plate size horns angled for safety



Multi Grip Chin Up Bar



Custom Logo Available
 \$299 Call BFS

Package Options



A Dip Attachment:
\$195
 #5EL18



B Technique Attachment:
\$275
 #5EL17



C Elite Plus Bench:
\$495
 #5EP07

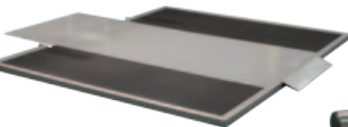

D Modular Elite Platform **\$1095**
 #6EL54HR



Shown with optional Bench

Elite Plus Half Rack
 Total Package

Package includes rack and options:
 1 x A, 1 x B, 1 x C

\$2595
 #6EP97TP

Save \$365
Off Retail

Elite Plus Half Rack Total
 Package with Platform

Package includes rack and options:
 1 x A, 1 x B, 1 x C, 1 x D

\$3625
 #6EP97TP1

Save \$430
Off Retail

Elite Half Rack with
 Platform

Package includes rack and options:
 1 x D

\$2695
 #6EP97P1

Save \$395
Off Retail

Elite Plus Double Sided Half Rack

Custom Colors See Page 1!
2" x 3" 7 Gauge Steel Construction

\$2595
#5EP98
I-44" w-64" h-95"

BUILT TO LAST:
Lifetime frame warranty

Standard Features



7-gauge chrome-plated bar catch adjustment rails



2 upright Olympic bar holders



Chrome-plated Olympic plate size horns angled for safety



Multi Grip Chin Up Bar



Custom Logo Available
\$299 Call BFS

Package Options



A Dip Attachment:
\$195
#5EL18



B Technique Attachment:
\$275
#5EL17



C Elite Plus Bench:
\$495
#5EP07

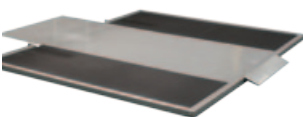

D Modular Elite Platform **\$1095**
#6EL54HR

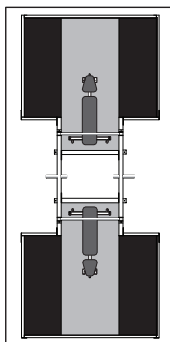

Elite Plus Double Sided Half Rack Total Package

Package includes rack and options:
2 x A, 2 x B, 2 x C,

\$3895
#6EP98TP

Save \$630
Off Retail

Elite Plus Double Sided Half Rack Total Package with 1 Platform

Package includes rack and options:
2 x A, 2 x B, 2 x C, 1 x D

\$4930
#6EP98TP1

Save \$690
Off Retail

Elite Plus Double Sided Half Rack Total Package with 2 Platforms

Package includes rack and options:
2 x A, 2 x B, 2 x C, 2 x D

\$5975
#6EP98TP2

Save \$740
Off Retail

Elite Plus Double Sided Half Rack with 1 Platform

Package includes rack and options:
1 x D

\$3295
#6EP98P1

Save \$395
Off Retail

Elite Plus Double Sided Half Rack with 2 Platforms

Package includes rack and options:
2 x D

\$4275
#6EP98P2

Save \$510
Off Retail



Elite Plus Full Cage

Custom Colors See Page 1!
 2" x 3" 7 Gauge Steel Construction
BUILT TO LAST:
 Lifetime frame warranty

\$1595
 #5EP96
 I-66" w-49" h-96"

Standard Features



HD Bar Catches



2 upright Olympic bar holders

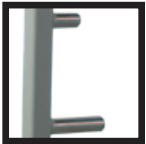

Chrome-plated Olympic plate size horns angled for safety



Multi Grip Chin Up Bar



Custom Logo Available
 \$299 Call BFS

Package Options



A Dip Attachment:
\$195
 #5EL182



B Technique Attachment:
\$275
 #5EL172



C Elite Plus Bench:
\$495
 #5EP07

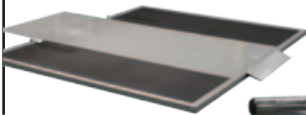

E Modular Elite Platform **\$1145**
 #6EL54FC

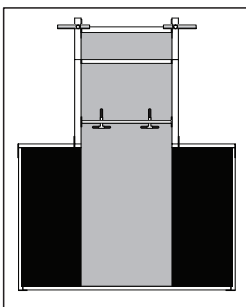

Elite Plus Full Cage Total Package

Package includes rack and options:
 1 x A, 1 x B, 1 x C

\$2295
 #6EP96TP

Save \$265
Off Retail

Elite Plus Full Cage Total Package with Platform

Package includes rack and options:
 1 x A, 1 x B, 1 x C, 1 x E

\$3375
 #6EP96TP1

Save \$330
Off Retail

Elite Plus Full Cage with Platform

Package includes rack and options:
 1 x E

\$2595
 #6EP96P1

Save \$145
Off Retail

Elite Plus Fixed Full Cage

Custom Colors See Page 1!
2" x 3" 7 Gauge Steel Construction

\$1595
#5EP95
I-66" w-49" h-96"

BUILT TO LAST:
Lifetime frame warranty

Standard Features

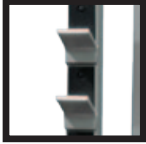

Fixed Bar Catches



2 upright Olympic bar holders



Chrome-plated Olympic plate size horns angled for safety



Multi Grip Chin Up Bar



Package Options



A Dip Attachment:
\$195
#5EL182



B Technique Attachment:
\$275
#5EL172



C Elite Plus Bench:
\$495
#5EP07

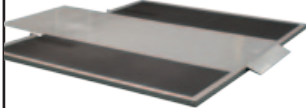

E Modular Elite Platform **\$1145**
#6EL54FC

Custom Logo Available
\$299 Call BFS

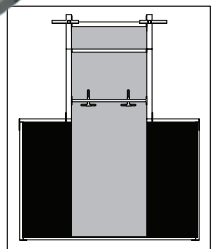

Elite Plus Fixed Full Cage Total Package

Package includes rack and options:
1 x A, 1 x B, 1 x C
\$2295
#6EP95TP

Save \$265
Off Retail

Elite Plus Fixed Full Cage Total Package with Platform

Package includes rack and options:
1 x A, 1 x B, 1 x C, 1 x E
\$3375
#6EP95TP1

Save \$330
Off Retail

Elite Plus Fixed Full Cage with Platform

Package includes rack and options:
1 x E
\$2595
#6EP95P1

Save \$145
Off Retail



Elite Plus Fixed Full Cage - Old School

Custom Colors See Page 1!

Base Rack
2" x 3" 7 Gauge Steel Construction
Massive 7-gauge steel construction
Lifetime frame warranty(40 inches)

\$995
#5EP94
I-66" w-49" h-96"

Elite Multi-Use Rack

Custom Colors See Page 1!
 2" x 3" 7 Gauge Steel Construction
BUILT TO LAST:
 Lifetime frame warranty

\$2,295
 #5EP99
 l-78" w-66" h-96"



Standard Features



HD Bar Catches



2 upright Olympic bar holders

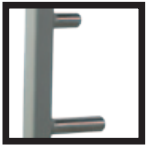

Chrome-plated Olympic plate size horns angled for safety



Multi Grip Chin Up Bar



Package Options



A Dip Attachment:
\$195
 #5EL182



B Technique Attachment:
\$275
 #5EL172



C Elite Plus Bench:
\$495
 #5EP07

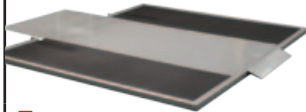

F Modular Elite Platform **\$1195**
 #6EL54MU

Custom Logo Available
 \$299 Call BFS

Elite Plus Multi-Use Rack Total Package

Package includes rack and options:
 1 x A, 1 x B, 1 x C **\$2895**
 #6EP99TP

Save \$365
Off Retail

Elite Plus Multi-Use Rack Total Package with Platform

Package includes rack and options:
 1 x A, 1 x B, 1 x C, 1 x F **\$3995**
 #6EP99TP1

Save \$460
Off Retail

Elite Plus Multi-Use Rack with Platform

Package includes rack and options:
 1 x F **\$3175**
 #6EP99P1

Save \$315
Off Retail



**Elite Power
Clean Platform**

6 Foot X 8 Foot

Custom Colors See Page 1!

Most durable, best-performing platform surface available
Features ProtectAll™ long-lasting vinyl surface

No warping. No wood. Solid rubber. Non-slip.

Our most popular power clean platform

Protectal gray lifting surface - three year warranty, logo not included

Custom Logo \$299

\$995

6EL5468
6ft. x 8ft. x 2in.

**Elite Power
Clean Platform
Competition Frame**

8 Foot X 8 Foot

Sized to competition standards

Custom Colors See Page 1!

\$1195

6EL5488
8ft. x 8ft. x 2in.



**Elite Plus Power
Clean Insert Platform**

Available as a modular insert for the D1 Half Racks and D1 Full Cage and Multi-Use Rack
See pages 19-23 for details

Half Rack Insert

\$1095

#6EL54HR

Full Cage Insert

\$1145

#6EL54FC

Multi Use Insert

\$1195

#6EL54MU

Custom Logo \$299





Custom Sweat Guards
3 or More Only

\$179 Each

#504SGL3



Elite Plus Flat to Incline Bench

Custom Colors See Page 1!

Easily adjusts from flat to military:
0, 30, 35, 45, 85 degrees
Heavy-duty: Built to last
Easy to move with handle and wheels

\$495

#5EP07
I-51" w-30" h-18"

Also Available:
Elite Flat to Incline Bench
(11 Gauge)

\$425

#5EL07



Elite Plus Multi-Angle Bench

Custom Colors See Page 1!

Easily adjusts from decline to military:
-20, 0, 30, 35, 85 degrees
Heavy-duty and very stable

\$595

#5EP14
I-57" w-30" h-29"

Also Available:
Elite Multi-Angle Bench
(11 Gauge)

\$525

#5EL14

Elite Plus Olympic Bench

Custom Colors See Page 1!

Without Plate Holders

\$545

#5EP01
L-49" w-48" h-47"

With Plate Holders

\$845

#5EP01PH
L-49" w-48" h-47"



Also Available:

Elite Olympic Bench w/Plate Holders
(11 gauge)

\$745 #5EL01PH

Elite Olympic Bench w/no Plate
Holders (11 gauge)

\$445 #5EL01

Elite Plus Olympic Incline

Custom Colors See Page 1!

Without Plate Holders

\$595

#5EP02
L-50" w-48" h-57"

With Plate Holders

\$895

#5EP02PH
L-50" w-48" h-57"



Also Available:

Elite Olympic Incline Bench w/Plate
Holders (11 gauge)

\$825 #5EL02PH

Elite Olympic Incline Bench w/no
Plate Holders (11 gauge)

\$525 #5EL02



Custom Sweat Guards
3 or More Only
\$179 Each

#504SGL3





Elite Plus Olympic Decline

Custom Colors See Page 1!

Without Plate Holders

\$665

#5EP03
l-57" w-48" h-47"

With Plate Holders

\$965

#5EP03PH
l-57" w-48" h-47"



Also Available:

Elite Olympic Decline Bench w/Plate Holders (11 gauge)

\$885 #5EL03PH

Elite Olympic Decline Bench w/no Plate Holders (11 gauge)

\$585 #5EL03



Elite Plus Olympic Military (Shoulder Press)

Without Plate Holders

\$625

#5EP04
l-36" w-48" h-57"

Custom Colors See Page 1!

With Plate Holders

New design Coming 2015

\$925

#5EP04PH
l-36" w-48" h-57"

Also Available:

Elite Olympic Military w/Plate Holders (11 gauge) New design for 2015

\$855 #5EL04PH

Elite Olympic Military w/no Plate Holders (11 gauge)

\$555 #5EL04



Spotter Stand
Attaches to Olympic Bench, Incline & Decline

\$145 #5EL13

BIGGER FASTER STRONGER - DEDICATED TO HELPING ATHLETES SUCCEED

BIGGER FASTER STRONGER

BFS

NICK SELLERS
Starting Strong
With BFS
p 4

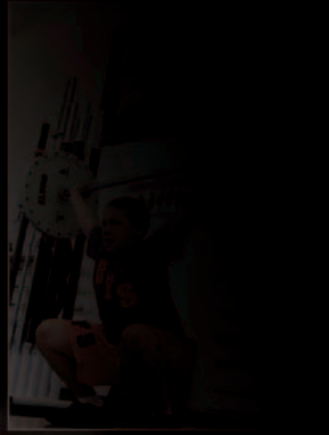

MAY/JUNE 2010 • \$5.95

No. 132



Varsity Line

At BFS we know the real measure of a weight room is the results you see outside the weight room. The Varsity line, built with 2" x 2" 11 gauge steel, has every rack, bench or platform you need to achieve your goals. The Varsity line is built for teams that know they have to work hard and get a little dirty to reach their dreams. Get started on your dreams with equipment that is as serious as you are.



The ultimate in team pride!

Custom nameplate cut from 7 gauge steel
5 or more only \$199 each

#501RKLB

All Varsity Racks, Platforms & Benches
Ship Free With Orders over \$3000

Pages 28 through 33

Inside Ground-
Based Training

p 40

What's New in
Flexibility Training

p 44

Varsity Half Rack

Custom Colors see Page 1!

2" x 2" 11 Gauge Steel Construction

High quality at a low price

\$1,195

#5VA97
l-44" w-64" h-95"

Standard Features



12 position adjustable bar catches



10 External Plate Holders for quick, easy access



Integrated chin up bar

Package Options



A Varsity Bench:
\$325
#5VA07

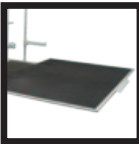

B Varsity Power Clean Platform:
\$595
#6VA54HR

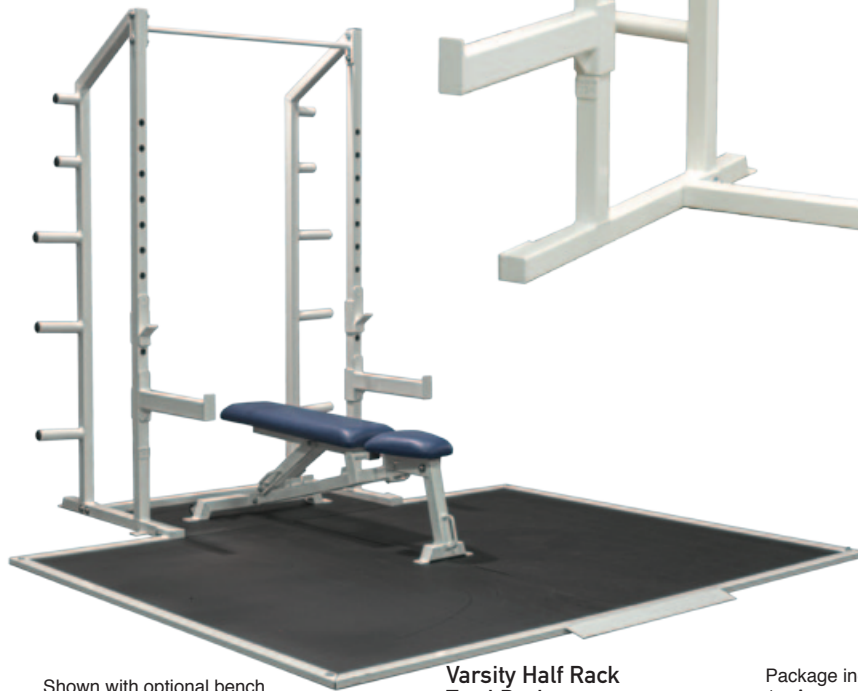

Shown with optional bench

**Varsity Half Rack
Total Package**

Package includes rack and options:
1 x A

\$1345
#6VA97TP

**Save \$175 Off
Retail**

**Varsity Half Rack
Total Package with Platform**

Package includes rack and options:
1 x A, 1 x B

\$1795
#6VA97TP1

**Save \$320 Off
Retail**

**Varsity Half Rack
with Platform**

Package includes rack and options:
1 x B

\$1545
#6VA97P1

**Save \$245 Off
Retail**

Varsity Racks & Platforms

Varsity Full Cage With Plate Holders

Custom Colors see Page 1!

2" x 2" 11 Gauge Steel Construction

High quality at a low price

\$895

#5VA96

l-44" w-64" h-95"

Standard Features



12 position adjustable bar catches



10 External Plate Holders for quick, easy access



Intergrated chin up bar

Package Options



A Varsity Bench:

\$325

#5VA07

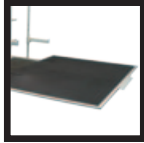

B Varsity Power Clean Platform:

\$645

#6VA54FC



Varsity Full Cage With Plate Holders Total Package

Package includes rack and options:
1 x A

\$1075

#6VA96TP

Save \$145 Off Retail

Varsity Full Cage With Plate Holders Total Package With Platform

Package includes rack and options:
1 x A, 1 x B

\$1645

#6VA96TP1

Save \$220 Off Retail

Varsity Full Cage With Plate Holders With Platform

Package includes rack and options:
1 x B

\$1365

#6VA96P1

Save \$175 Off Retail

Varsity Full Cage

Custom Colors see Page 1!

2" x 2" 11 Gauge Steel Construction

High quality at a low price

\$595

#5VA95

l-44" w-64" h-95"



Varsity Full Cage Total Package

Package includes rack and options:
1 x A

\$795

#6VA95TP

Save \$125

Off Retail

Varsity Full Cage Total Package With Platform

Package includes rack and options:
1 x A, 1 x B

\$1385

#6VA95TP1

Save \$180

Off Retail

Varsity Full Cage With Platform

Package includes rack and options:
1 x B

\$1095

#6VA95P1

Save \$145

Off Retail

Varsity Double Sided Half Rack

Custom Colors see Page 1!

2" x 2" 11 Gauge Steel Construction

High quality at a low price

\$1595

#5VA98
1-44" w-64" h-95"

Standard Features



12 position adjustable bar catches



10 External Plate Holders for quick, easy access



Integrated chin up bar

Package Options



A Varsity Bench:
\$325
#5VA07

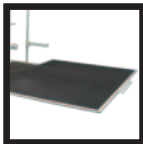

B Varsity Power Clean Platform:
\$595
#6VA54HR

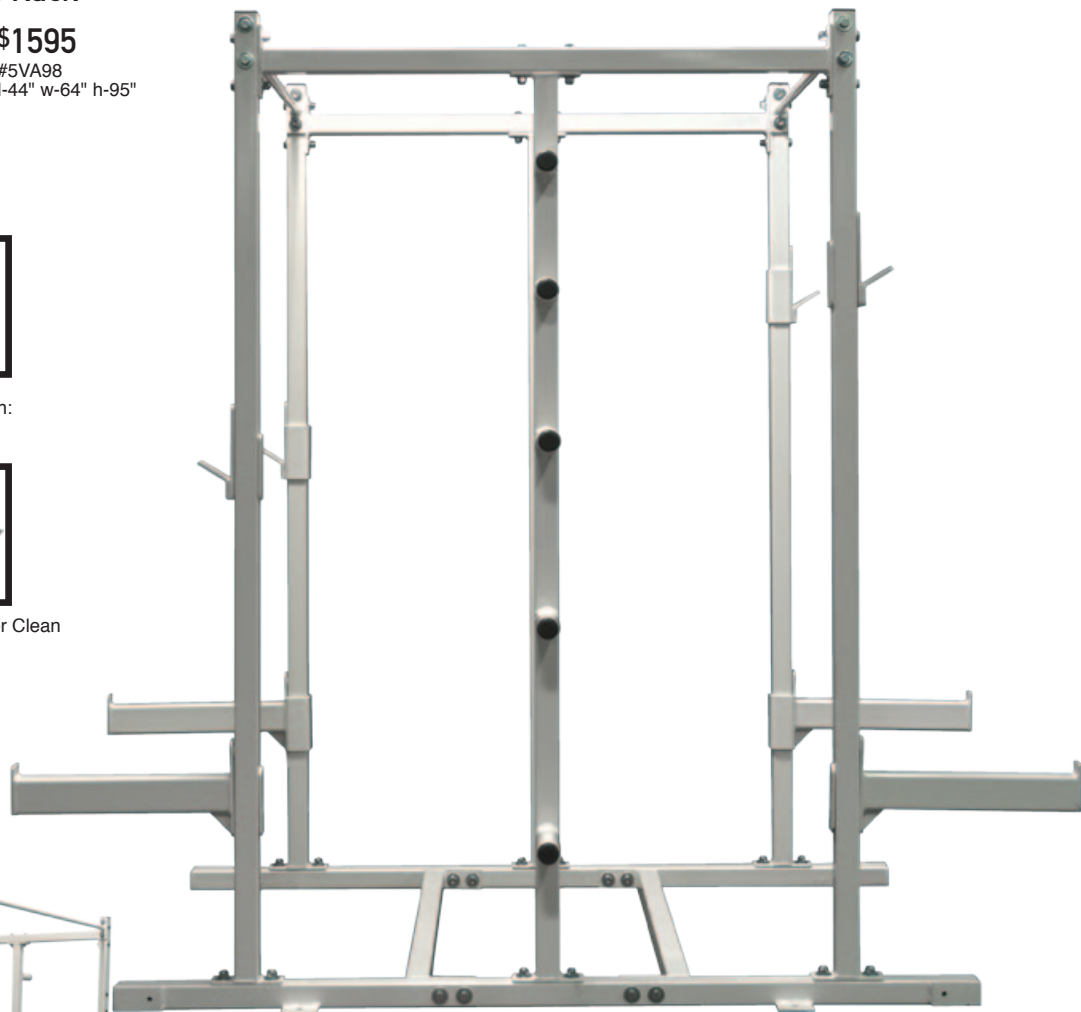

Varsity Double Sided Half Rack Total Package	Package includes rack and options: 2 x A	\$1970 #6VA98TP	Save \$275 Off Retail
Varsity Double Sided Half Rack Total Package With 1 Platform	Package includes rack and options: 2 x A, 1 x B	\$2530 #6VA98TP1	Save \$310 Off Retail
Varsity Double Sided Half Rack Total Package With 2 Platforms	Package includes rack and options: 2 x A, 2 x B	\$2995 #6VA98TP2	Save \$440 Off Retail
Varsity Double Sided Half Rack With 1 Platform	Package includes rack and options: 1 x B	\$1895 #6VA98P1	Save \$295 Off Retail
Varsity Double Sided Half Rack With 2 Platforms	Package includes rack and options: 2 x B	\$2425 #6VA98P2	Save \$360 Off Retail

Varsity Power Clean Platform 6' x 8'

Custom Colors see Page 1!

\$495

#6VA5468
6ft. x 8ft. x 1in.

Varsity Power Clean Platform Competition Size 8' x 8'

Custom Colors see Page 1!

\$695

#6VA5488
8ft. x 8ft. x 1in.

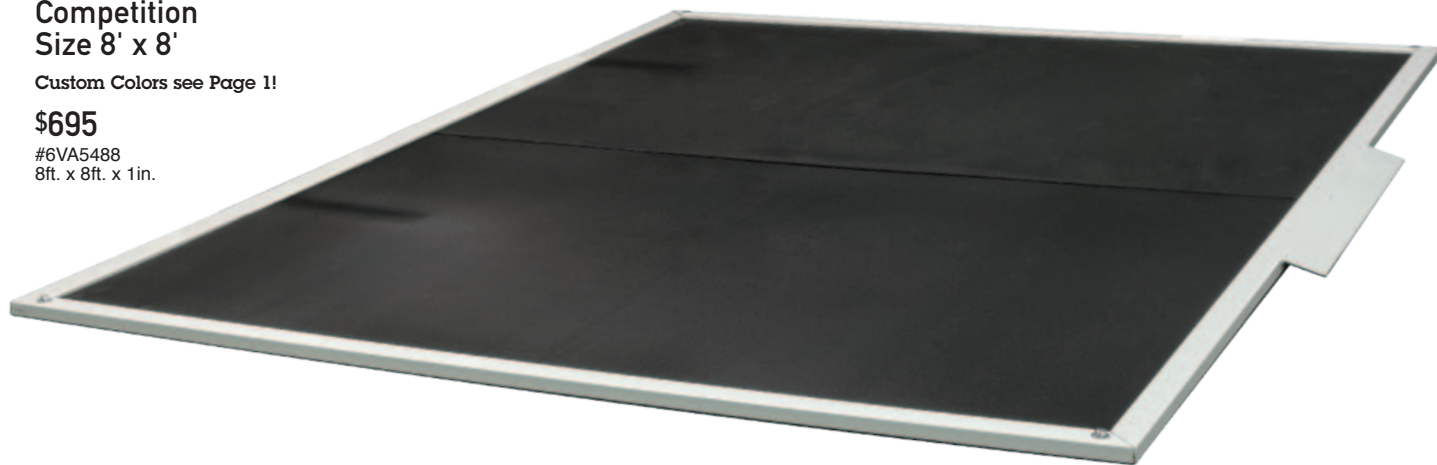

Varsity Power Clean Modular Platform'

Available as a modular insert for the Varsity Half Racks and Varsity Full Cage.
See pages 29, 30 and 31 for details

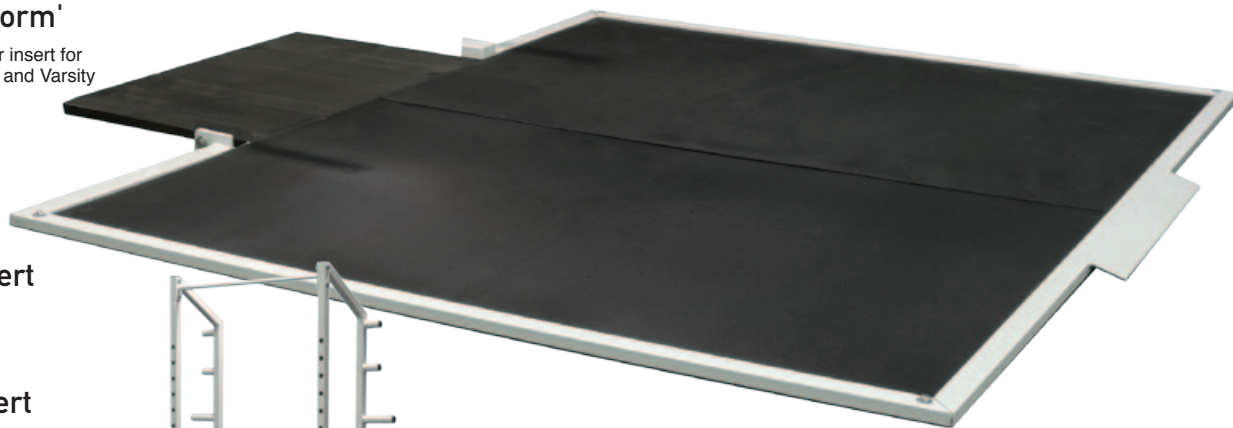

Half Rack Insert

\$595

#6VA54HR

Full Cage Insert

\$645

#6VA54FC

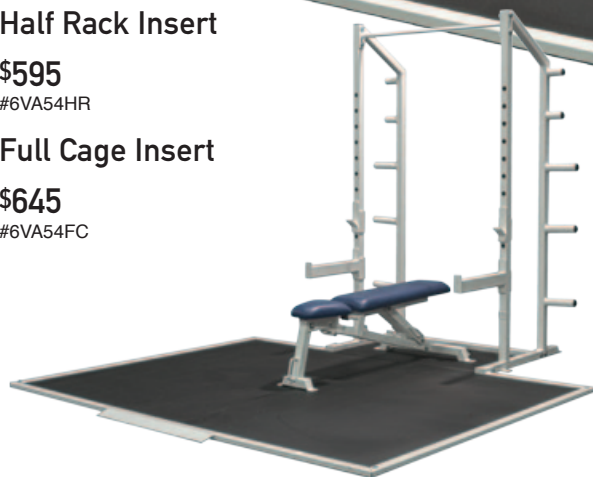

Varsity Benches

Varsity Flat Bench to Incline

Custom Colors see Page 1!

Easily adjusts from flat to military:
0, 30, 35, 45, 85 degrees

Easy to move with handle and wheels

\$325

#5VA07
l-51" w-30" h-18"



Custom Sweat Guards
3 or More Only

\$179 Each

#504SGL3

Varsity Olympic Bench

Custom Colors see Page 1!

Heavy-duty

\$345

#5VA01
l-51" w-30" h-18"



Varsity Olympic Incline Bench

Custom Colors see Page 1!

Built to last

\$395

#5VA02
l-51" w-30" h-18"



All Specialty Racks & Benches Ship Free With Orders over \$1000

Pages 34 through 37



Specialty Racks

Training comes in many forms and programs. Individual sports, individual goals, individual results can require specialized equipment. BFS has you covered with racks platforms and benches crafted for every weight room. No matter the desired result we can get you there!



Space-Saver Rack

Custom Colors See Page 1!

Allows user to perform all BFS core lifts and many more

Easily folds for storage (24")

Includes weight stack for all auxiliary lifts

Built in bar, accessories holders and plate racks

Includes heavy-duty multi-angle bench (flat/incline/military/decline)

\$4,395

#6SP39B
1-49" w-48" h-84"

Space-Saver Rack Plate Loaded

All the benefits and you can save by using you can save by using your own plates!

Or purchase plates for even more versatility - See page 82

\$3,795

#6SP39BPL

Unilateral Power Press

Custom Colors See Page 1!

- Total body workout
- Great for explosive training
- Develop strength, balance and coordination
- Perform extension and rotation
- Unilateral design
- Heavy duty – designed for the strongest athletes
- Weight plate attachments

\$1,445

#5SP95
l-64" w-72" h-88"



(Unit must be bolted to floor)

Multi-use Rack

Custom Colors See Page 1!

- Offers unparalleled safety
- Never feel cramped (46 inches of work space)
- Rock solid durability: massive 7-gauge steel
- Lifetime frame warranty
- Bench sold separately

\$2,095

#5SP99
l-78" w-66" h-70"



Dip Attachment

\$195

#5EL18



46"



Counterbalanced Smith Machine

Custom Colors See Page 1!

Smooth, consistent movement due to quad-linear bearing system

Counter balanced bar for 20 lbs. starting weight

Without Plate Holders

\$1,795

#5SP52
l-57" w-86" h-86"

Counterbalanced Smith Machine With Plate Holders

Custom Colors See Page 1!

\$1,995

#5SP52PH
l-57" w-86" h-86"



Angled Squat Rack

Custom Colors See Page 1!

Built super strong for high-volume use

6 fixed bar holders for accurate positioning

Without Plate Holders

\$595

#5SP42
l-57" w-49" h-70"

Angled Squat Rack With Plate Holders

Custom Colors See Page 1!

\$695

#5SP42PH
l-57" w-49" h-70"



**Olympic
4-in-1 Bench**

Custom Colors See Page 1!

Easily adjusts between Olympic decline, Olympic bench, Olympic Incline and Olympic military (-20, 0, 30, 85 degrees)

Built sturdy for your strongest athletes

\$645

#5SP05
l-67" w-48" h-57"

**Military
(shoulder press)**



Flat



Decline



**Flat
Bench**

\$245

#5SP06
l-46" w-24" h-18"

**Adjustable
Decline**

\$465

#5SP09
l-60" w-26" h-24"

**Seated
Bench**

\$285

#5SP10
l-26" w-24" h-39"

Custom Colors See page 1!

BXI Series

BFS w the BXI Series of racks and rigs. Quality components, in a huge variety of configurations, powered by over 37 years of experience, guarantees a modular system like no other. Built with primarily 3" X 3" 11 gauge steel tubes these rigs and their auxiliaries have all the functionality and durability to stand up to the toughest work outs.

BXI Plus line is also available in heavier 7 gauge steel - call for pricing.



MADE IN THE USA

All BXI and BXI Plus Racks & Equipment Ship Free With Orders over \$2000

Pages 38 through 43

BXI Modular Components

Uprights

8' Upright	5BXUP8	\$145
9' Upright	5BXUP9	\$160
10' Upright	5BXUP10	\$175
11' Upright	5BXUP11	\$190
12' Upright	5BXUP12	\$205



Note: All BXI Rigs & Racks must be solidly secured to structural elements. Must be bolted to the floor and to a solid wall or wall support. No hardware is included for mounting. It is recommended to hire a professional to ensure proper installation.

Connectors

42" Single Connector	5BXSC42	\$70
42" Double Connector	5BXDC42	\$100
42" Triple Connector	5BXTC42	\$115
48" Single Connector	5BXSC48	\$80
48" Double Connector	5BXDC48	\$110
48" Triple Connector	5BXTC48	\$125
60" Single Connector	5BXSC60	\$85
60" Double Connector	5BXDC60	\$115
60" Triple Connector	5BXTC60	\$130
69" Double Connector	5BXDC68	\$130
72" Double Connector	5BXDC72	\$140
84" Double Connector	5BXDC84	\$145

Attachments

Bar Catches	5BXBC	\$85
Bar Safeties	5BXS	\$130
Dip Attachment	5BX18	\$170
Step Up Platform	5BXSU	\$185
Land Mine	5D197LM	\$145
Wall Ball Target	5BXWBT	\$170
Plate Storage Peg	5BXPSP	\$30
Ceiling/Wall Anchor	5BXCWA	\$45
Double Land Mine	5D1DLM	\$225
D-Clip	5D1RADL	\$165



Includes adjustable band pegs



Includes adjustable band pegs

BXI Floor Mounted Rigs - Construct your own (see page 38) or purchase one of the kits shown below and save

BXI Power Rack - Welded Sides

36" Deep

30" Deep

BXI Power Rack - Bolt Together

36" Deep

30" Deep

\$775 #5BXGR36W

\$700 #5BXGR30W

\$800 #5BXGR36BT

\$725 #5BXGR30BT

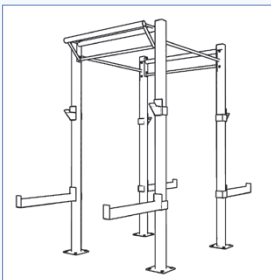

Base Rig - 8' \$935
#6BXFS8
Base Rig - 10' \$995
#6BXFS10

4	8' or 10' Uprights
2	48" Single Connectors
1	42" Double Connector
1	42" Triple Connector
4	Bar Catches
4	Safety's

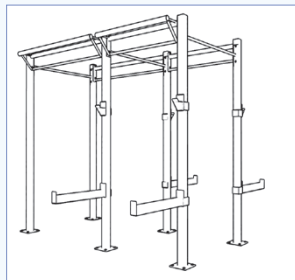

Base Rig +1 - 8' \$1245 #6BXFS8P
Base Rig +1 - 10' \$1345 #6BXFS10P

6	8' or 10' Uprights	1	60" Double Connector
3	48" Single Connectors	1	60" Triple Connector
1	42" Double Connector	4	Bar Catches
1	42" Triple Connector	4	Safety's

8' Add On \$1055 #6BXFS8A

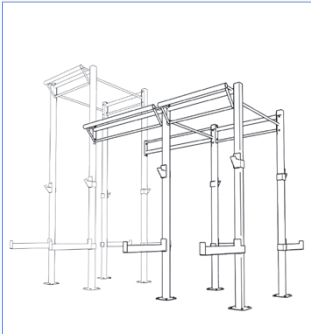

9' Add On \$1085 #6BXFS9A

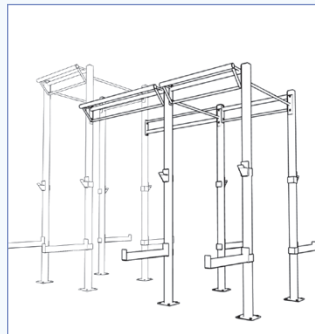

10' Add On \$1115 #6BXFS10A

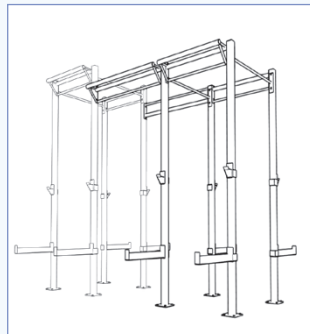

11' Add On \$1145 #6BXFS11A

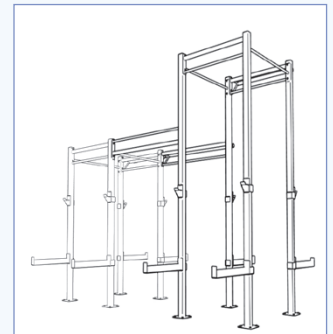

12' Add On \$1175 #6BXFS12A

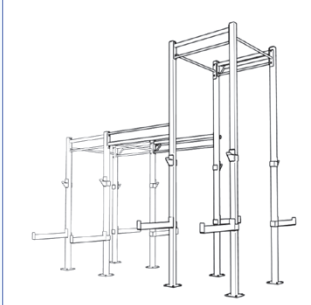

All Add On Pkgs include

4	8', 9', 10', 11', or 12' Uprights
2	48" Single Connectors
1	42" Double Connector
1	42" Triple Connector
1	60" Double Connector
1	60" Triple Connector
4	Bar Catches
4	Safety's

Attachment Package \$565 #6BXAP

1	Landmine	1	Wall Ball Target
1	Dip Attachment	1	Step Up Platform

See Page 42 for description of these products

BXI Series - Wall Mounted



BXI Wall Mounted Rigs - Construct your own (see page 38) or purchase kits on this page and save

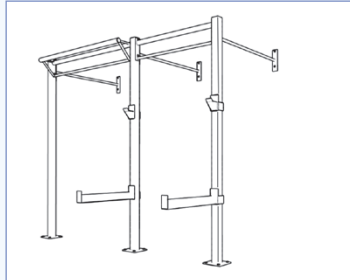
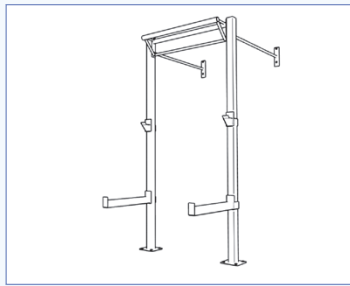

Base Wall Rig - 8' \$485 #6BXWM8
 Base Wall Rig - 10' \$535 #6BXWM10

2	8' or 10' Uprights
2	48" Single Connectors
1	42" Double Connector
2	Bar Catches
2	Safety's

Base Wall Rig +1 - 8' \$700 #6BXWM8P
 Base Wall Rig +1 - 10' \$740 #6BXWM10P

3	8' or 10' Uprights
3	48" Single Connectors
1	42" Double Connector
1	60" Triple Connector
2	Bar Catches
2	Safeties

8' Add On \$570 #6BXWM8A

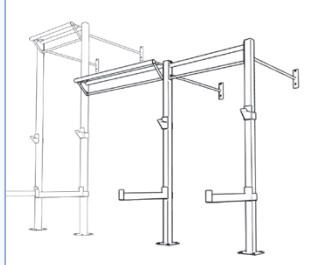

9' Add On \$585 #6BXWM9A

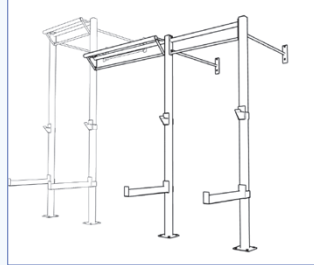

10' Add On \$600 #6BXWM10A



All Add On Packages Include

2	8', 9', 10', 11', or 12' Uprights
2	48" Single Connectors
1	42" Double Connector
1	60" Triple Connector
2	Bar Catches
2	Safety's

11' Add On \$625 #6BXWM11A

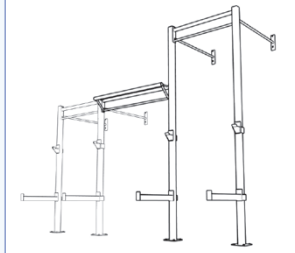

12' Add On \$645 #6BXWM12A

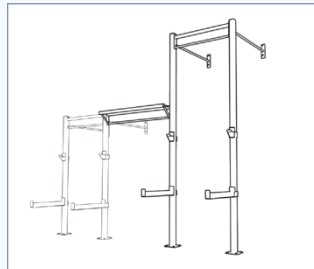

Attachment Package \$565 #6BXAP

1	Landmine	1	Wall Ball Target
1	Dip Attachment	1	Step Up Platform

See Page 42 for description of these products



BXI Power Squat Stand

Includes
 2 Safeties
 and 2 Bar
 Catches

\$395
 #6BXSSP



BXI Squat Stand

Includes
 2 Safeties
 and 2 Bar
 Catches

\$495
 #6BXSS



BXI Double Sided Half Rack

Includes 4 Safeties
and 4 Bar Catches

\$1895
#5BX98

Optional Platform
\$845
#6BX54HR



BXI Half Rack

Includes 2 Safeties
and 2 Bar Catches

\$1445
#5BX97

Optional Platform
\$845
#6BX54HR



BXI Full Cage

I-68" w-49" h-102"

With Plate Holders

\$1145
#5BX96

Without Plate Holders

\$1095
#5BX95

Optional Platform
available

\$895
#6BX54FC

Standard BXI Black
Straight Chin Up Bar
Quick straight solid bar
safeties
See www.biggerfasterstronger.com for
updated 2015 images

All new updated for 2015! See online
at biggerfasterstronger.com

BXI Series



BXI Land Mine Attachment
\$195
 #5D1LM



BXI Double Land Mine
\$225
 #5D1DLM



BXI Wall Ball Target
\$185
 #5BXWBT



BXI Dip Attachments
\$195
 #5EL18



BXI Safety (Pair)
\$145
 #5BXS

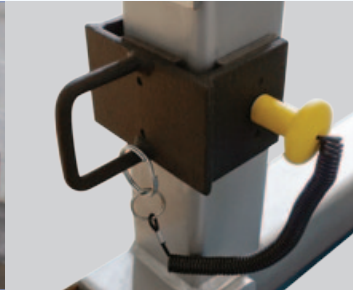

BXI D-Clip
\$165
 #5D1RADC



BXI Step Up Platform
\$195
 #5BXSU



BXI Bar Catch (Pair)
\$95
 #5BXBC

BXI Wall Mounted Modular Chin Up Bars



8' Set of the 2 X 2 X 24 BXI Modular Chin Up Bars



Mounting width can be set on any distance stud centers up to 48"

Units come with NO mounting hardware Professional Contractor Installation Required

Expansion Sets Available. Check online for details or call 800-628-9737

BXI 3 X 3 X 36

Heavy Duty 3" x 3" 11 gauge brackets

Stands 3 feet off the wall

4 Foot Set

\$200

#5BX1001
 l-50" w-36" h-19"

8 Foot Set

\$315

#5BX1002
 l-100" w-36" h-19"

12 Foot Set

\$430

#5BX1003
 l-150" w-36" h-19"

BXI 2 X 2 X 24

2" x 2" 11 gauge brackets

Stands 2 feet off the wall

4 Foot Set

\$145

#5101001
 l-50" w-24" h-19"

8 Foot Set

\$230

#5101002
 l-100" w-24" h-19"

12 Foot Set

\$315

#5101003
 l-150" w-24" h-19"



BXI Dog Sled

\$265

#5BX451



BXI Farmer's Walk

\$195 pair

#5BXFW



BXI 9 Bar Storage Rack

\$155

#5BX9VBS



BXI Mobile Bumper Storage Rack

\$125

#5BXMBS



Ceiling/Wall Anchor

\$45

#5BXCWA



BXI Glute Ham Developer

Built in band resistance pegs

Built in wheels for mobility

\$600

#5BX30BP

Crossfire Conquest (8 to 16 Person Station)

EIGHT STATIONS

1. Olympic Half Rack
 2. Ring Tower Station
 3. Plyo/Step Up Station
 4. Kettlebell Station
 5. Medicine Ball Station
 6. Adjustable Push/Pull Station
 7. Heavy Bag Attachment (config 1 only)
 - 7a. Optional Cable Column (config 2 only)
 8. Interior Training Station
- Inner Mat Not Included

Over 100 different functional movements in 8 stations and occupies an area approximately 20' x 20'.

Massive 11-gauge steel construction



Configuration 1:
Conquest with Heavy Bag Attachment*

*Heavy Bag not included

\$8,995

ITEM #5BXCC1



Configuration 2:
Conquest with High-Low Pulley, 400 lb. weight stack/100 lbs Resistance, Cable Belt and Single Handle

\$9,995

ITEM #5BXCC2

Four pulley cable system allows for an 18 foot range - Great for sprint work and much, much more!

Absolute Oval Line

Bigger Faster Stronger is always looking for new forms and materials from which to deliver the finest weight training equipment to our discerning customers. Combining a steel oval pipe with highly durable and impact resistant UHMW we have crafted a line of equipment that is as striking as it is functional.

**All Absolute Oval Racks & Benches
Ship Free With Orders over \$4000**

Pages 44 through 49



Absolute Multi Use Rack

Custom Colors See Page 1!
The one station that does it all. The Absolute Multi-Use Rack the apparatus to do a majority of major lifts.

\$1995

#5AB99
77" x 67" x 92"



Absolute Smith Machine

Custom Colors See Page 1!
Smooth motion with easy lift-off design

The Counter Balanced Smith Machine is a staple in weight rooms around the world. The Absolute line has your squats covered with this elegant apparatus

\$2875

#5AB52
52" x 86" x 86"

Absolute Chin Dip/VKR

Custom Colors See Page 1!

Body weight king! The Chin, Dip and VKR (Vertical Knee Raise) gets the maximum versatility out of it's small footprint.

\$795

#5AB32
48.5" x 48.5" x 85"





Absolute 4-1 Olympic Bench

Custom Colors See Page 1!
 A weightroom must!
 This bench has it all! Perform every
 press for a total upper body work out!

\$1195
 #5AB05
 65.5" x 50" x 56.5"



Absolute Olympic Incline Bench

Custom Colors See Page 1!
 A weightroom must!
 30 degree angle
 7 position adjustable seat
 Bar Catch at 37" and 46"

\$985
 #5AB02
 I-60" w-48" h-83"



Absolute Olympic Bench

Custom Colors See Page 1!
 The Absolute Olympic Bench performs
 with grace and power

\$875
 #5AB01
 60" x 50" x 45"



Absolute FID Bench

Custom Colors See Page 1!
 Multiply your workouts with the
 Absolute Flat, Incline and Decline
 Bench

\$595
 #5AB14
 77" x 50" x 94.5"





Absolute Flat Bench

Custom Colors See Page 1!
A weightroom must!

Absolute Flat Bench with a small footprint is the perfect companion to dumbbell or curl bar work out

\$315

#5AB06
56" x 26.5" x 16.5"



Absolute Adjustable Decline

Custom Colors See Page 1!
A weightroom must!

Dumbbells to abs this adjustable bench will make your workouts a killer with increased variety

\$655

#5AB09
62" x 26.5" x 26"



Absolute Seated Bench

Custom Colors See Page 1!

Expand your dumbbell options and perfect your form with an Absolute Line seated bench

\$395

#5AB10
44" x 26.5" x 37"



Absolute Arm Curl Bench

Custom Colors See Page 1!

The answer for specific targeted lifts

\$625

#5AB11
45" x 32" x 35"





Absolute Seated Calf

Custom Colors See Page 1!
Get Specific with this plate loaded calf machine

\$695
#5AB22
55.5" x 27" x 35"



Absolute 45° Hyper

Custom Colors See Page 1!
Your back is just as important as your abs for your core work, the Absolute 45 Degree Hyperextension is the solution!

\$585
#5AB31
47" x 36" x 29"



Absolute 5 Foot 3 Tier Dumbbell Rack

Custom Colors See Page 1!
Keep your weight room safe and orderly with storage designed to hold your dumbbells
Also Available in 2 Tier. \$555 #5AB46

\$675
#5AB47
30" x 66" x 41.5"



Absolute 10 Foot 3 Tier Dumbbell Rack

Custom Colors See Page 1!
Keep your weight room safe and orderly with storage designed to hold all your dumbbells
Also Available in 2 Tier. \$875 #5AB48

\$995
#5AB49
30" x 128" x 41.5"

For additional storage options see page 75



Plate Loaded Upper Body Equipment

Plate Loaded Lat Machine

Custom Colors See Page 1!
Super smooth movement

Side-load carriage for quick weight changes

Adjustable seat for optimal positioning

\$935

#51025
l-49" w-24" h-92"



Low Pulley Attachment

\$185

#51026



Seated Row



Pec Dec

Custom Colors See Page 1!
The classic movement to isolate pectorals

Side-load carriage for quick and easy weight changes

Super smooth movement

Adjustable seat for optimal positioning

\$915

#51024
l-59" w-45" h-73"





4-Way Neck Machine

Custom Colors See Page 1!
 Four patterns of resistance
 Reduces risk of injury
 Great for rehab
 Improve posture
 Easy in, easy out
 Seat design fits all athletes
 Unbeatable price!

\$455

#51023
 l-36" w-21" h-58"



Works great with chains



Bent Knee Sit-Up Bench

\$535

#51337
 l-73" w-17" h-15"

Single Ladder

\$395

#51334
 l-27" w-24" h-34"

Flat Sit-Up Bench

\$465

#51336
 l-73" w-17" h-21"

Double Ladder

\$455

#51335
 l-67" w-24" h-34"
 Custom Colors See Page 1!

Incline Lever Row

Custom Colors See Page 1!
Smooth motion with easy lift-off design

Dual-position rubber hand grips
Comfortable, high-density chest pad
Adjustable foot platform

\$685

#51027
l-75" w-36" h-49"



T-Bar Row

Custom Colors See Page 1!
Designed to handle strongest athletes

Three grip positions
Non-skid diamond tread plate

\$665

#51028
l-86" w-35" h-23"



Arm Curl Bench

Custom Colors See Page 1!
Adjustable seat for ideal positioning

Convenient barbell supports
Compact, sturdy design

\$445

#51011
l-42" w-30" h-36"





Straight V-Dip

Custom Colors See Page 1!
 Combination Parallel/V-handles
 accommodate all athletes
 Built for heavy-duty use
 Solid 2" oversized handles for comfort
 Convenient step-bar for easy access

\$395

#51033
 l-35" w-28" h-59"



Chin-Dip V.K.R.

Custom Colors See Page 1!
 A weightroom must!
 Perform three great
 auxiliary exercises
 Convenient step-bar for
 easy access
 Compact and incredibly sturdy

\$625

#51032
 l-60" w-48" h-83"



V.K.R. (Vertical Knee Raise)



Sit-up Bench

Custom Colors See Page 1!

Versatile sit-up bench – great for lower ab work
Comfortable padding and secure foot roller

\$385

#51312
L-43" w-24" h-28"



45° Hyper Extension

Custom Colors See Page 1!

Angled design and handles provide easy in, easy out

Comfortable, adjustable pelvic pad with rounded corners

Ankle pads and angled footplate for secure positioning

\$425

#51331
L-40" w-29" h-36"



Plate Loaded Ab Crunch

Custom Colors See Page 1!

Floating pivot point allows abdominal isolation
Plate Loaded

Comfortably stabilizes lower back and neck
Easy entry and exit

\$775

#51316
L-62" w-34" h-40"





Incline Press

Adjustable seat ensures perfect form
Bench press variation that emphasizes shoulder development

\$925

#52292
l-77" w-54" h-39"



Lat Pull

Three hand positions
Simulates lat pulldown

\$995

#52294
l-68" w-54" h-53"

Custom Colors See Page 1!

Call for shipping lead times on all lever equipment
Perfect complement to any free-weight weightroom
Minimizes joint stress

Smooth, natural predetermined movement
Space efficient, innovative designs

User-friendly adjustable starting positions
Low starting resistance levels

Plate Loaded Lever Features

Flange Bearings



- years of smooth operation

Mostly-Welded Frame

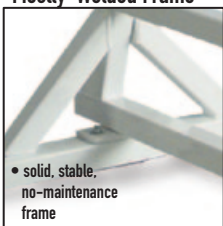

- solid, stable, no-maintenance frame

Chrome Plate Pins & Slides

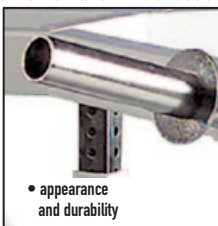

- appearance and durability

Adjustable Starting Point

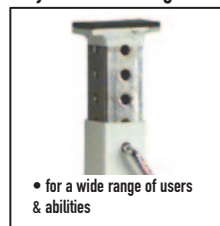

- for a wide range of users & abilities

No Spotter Required



- safe and easy to operate

Chest Press

Simulates free-weight bench press no spotters required
Works all the major upper body pressing muscles

\$875

#52291
l-74" w-54" h-30"



Military/Shoulder Press

Simulates military press
Adjustable backrest ensures perfect, upright posture

\$925

#52293
l-57" w-54" h-48"



Custom Colors See Page 1!

Call for shipping lead times on all lever equipment
Perfect complement to any free-weight weightroom
Minimizes joint stress

Smooth, natural predetermined movement
Space efficient, innovative designs

User-friendly adjustable starting positions
Low starting resistance levels

Plate Loaded Lever Features

Flange Bearings



- years of smooth operation

Mostly-Welded Frame

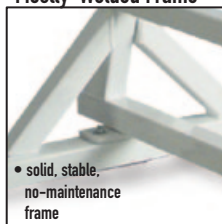

- solid, stable, no-maintenance frame

Chrome Plate Pins & Slides

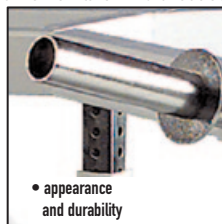

- appearance and durability

Adjustable Starting Point

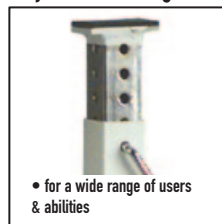

- for a wide range of users & abilities

No Spotter Required



- safe and easy to operate



Glute Ham Developer

Custom Colors See Page 1!

Our most popular glute ham developer
Dual adjustable ankle pads for
secure fit

High-density thigh pad

\$715

#50730
l-61" w-30" h-47"



Beginner Glute/ Ham Developer

Custom Colors See Page 1!

Knee pad ensures perfect form
Comfortable angled foot support
Rotating thigh pads reduce friction
on upper thighs

\$925

#50738
l-61" w-30" h-47"



**Guarantees
Proper
Knee Placement**





Squat Press

\$1,885

#50790
l-95" w-84" h-56"

Custom Colors See Page 1!

A leg press built to improve athletic performance, a great squat variation

Innovative design, superior biomechanics

Incorporates hamstrings

and glutes

Storage plate holders on back

Variable resistance minimizes stress

on the knees and hips

3-Way Hip Sled

\$1,655

#50720
l-94" w-36" h-60"

Custom Colors See Page 1!

Our most popular lower body machine!

Innovative design with optimal 45-degree angle

Built tough: Heavy-duty 11-gauge steel with massive 7-gauge channel

Space-efficient design with weight holders under carriage



Plate Loaded Leg Curl & Extension

Custom Colors See Page 1!

Innovative dual-function design

Heavy-duty: Built for the most demanding facilities

Adjustable leg curl/leg extension pad

\$635

#50721
l-65" w-25" h-30"



Plate Loaded Reverse Back Extension

Custom Colors See Page 1!

Small footprint

Pivot point properly aligned with hips

Decline chest pad reduces low back strain

Adjustable safety stop provides maximum range of motion for athletes, to limited range of motion for rehabilitation

\$1195

#50729
l-62" w-41" h-50"





Seated Calf

Custom Colors See Page 1!

Angled footplate for max range of motion
Adjustable knee pad accommodates any-size athlete

\$475

#50722
l-50" w-24" h-36"



Plate Loaded Standing Calf

Custom Colors See Page 1!

Call for shipping lead times
Isolates upper calf
Comfortable, high-density shoulder pads

\$1,435

#516115A
l-52" w-52" h-65"



BFS Adjustable Step

Custom Colors See Page 1!

Sturdy, broad foot plate
Adjustable heights for a full range of motion
Incremental adjustments from 6 to 26 inches

\$495

#50719
l-50" w-24" h-36"





Low Pulley Attachment

\$185

#51026

Selector Lat Pull

Custom Colors See Page 1!

Pulley Attachment optional

Our lowest-priced selector lat pull
Adjustable seat for optimal positioning
200-lb weight stack with 5-year warranty
Optional low pulley attachment
Call for shipping lead times on all selector equipment

\$1,475

#510100
I-49" w-24" h-92"

Elite Lat Pull

Custom Colors See Page 1!

Call for shipping lead times on all selector equipment

Weight stack faces user for easy adjustment
Adjustable, high-density thigh pads
200-lb weight stack with 5-year warranty

\$1,845

#516106
I-42" w-37" h-90"

4 Stack Functional Trainer

\$6,495

#516130
L-103" w-183" h-89"

Custom Colors See Page 1!
Strength facility staple

Lat Pulls and Low pulls offer 200lb Weight Stacks / 200lb Resistance

Functional Trainer offers 2 x 200-lb weight stacks/ 100lb resistance with 5-year warranty

Extremely compact footprint. Allows utilization of corners and wall space

Chin-Up Station

Several configurations available to meet your facilities individual needs

Add a dual lat pull down or an adj. cable crossover - Call BFS to learn more about this versatile station

Small footprint fits into corners for maximum efficiency



Functional Trainer

Custom Colors See Page 1!

Call for shipping lead times on all selector equipment

Adjustable, 12 position swivel pulleys with independent weight stacks

Perfect for Swiss ball and Bosu exercises

Angled chin-up bar with handles

Requires less floor space than standard cable crossover

200-lb weight stack (100 lbs resistance per side) with 5-year warranty

\$2,695

#516102C
l-123" w-42" h-89"



Adjustable Cable Crossover

Custom Colors See Page 1!

Call for shipping lead times on all selector equipment

The ultimate cable pulley system

12-position, super-smooth pulleys

Angled chin-up bar with handles

Stabilizing handles for perfect form

200-lb weight stack (100 lbs resistance per side) with 5-year warranty

\$2,695

#516102A
l-157" w-35" h-96"



Cable Crossover

Custom Colors See Page 1!

Call for shipping lead times on all selector equipment

A great value!

High and low pulleys

200-lb weight stack (100 lbs resistance per side) with 5-year warranty

\$2,095

#516102
l-134" w-35" h-96"





Vertical Chest Press

Custom Colors See Page 1!

Call for shipping lead times on all selector equipment

Comfortable, oversized, two-position handles

Foot controlled pre-stretch

Adjustable seat ensures optimal positioning

200-lb weight stack with 5-year warranty

\$1,845

#516101
 1-52" w-52" h-65"



Pec Dec/Rear Delt

Custom Colors See Page 1!

Call for shipping lead times on all selector equipment

Two great exercises in one: Pec Dec and Rear Delt

Pop pins allow easy exercise conversion

Adjustable seat and backrest ensure optimal positioning

200-lb weight stack with 5-year warranty

\$1,995

#516103
 1-53" w-48" h-82"



Selector Upper Body Equipment

Assisted CHIN/DIP

Custom Colors See Page 1!

Call for shipping lead times on all selector equipment

Heavy Duty: over 1/4 ton of high quality steel

Adjustable / retractable footplate

200-lb weight stack with 5-year warranty

Easy on - easy off platform steps

Perform dips and four types of chin-ups

\$2,495

#516117

l-55" w-51" h-65"



Dips



Chins

Military/ Shoulder Press

Custom Colors See Page 1!

Call for shipping lead times on all selector equipment

Adjustable seat and backrest ensure optimal positioning

Ability to change weights while seated

200-lb weight stack with 5-year warranty

Comfortable, oversized, two-position handles

\$1,795

#516104

l-55" w-51" h-65"



Arm Curl

Custom Colors See Page 1!

Call for shipping lead times on all selector equipment

Provides constant tension through out exercise

Adjustable seat and chest pad ensure proper positioning

200-lb weight stack with 5-year warranty

\$1,845

#516108
l-54" w-44" h-65"



Tricep Pushdown



Double Tricep

Custom Colors See Page 1!

Call for shipping lead times on all selector equipment

Perform French press and tricep pushdowns on one machine

Heavy-duty construction

Angled bench and adjustable seat encourage perfect form

200-lb weight stack with 5-year warranty

\$1,995

#516109
l-79" w-37" h-74"



Seated Row

Custom Colors See Page 1!

Call for shipping lead times on all selector equipment

Design enables user to perform numerous upper and mid-back exercises

220-lb weight stack with 5-year warranty

Front-loading weight stack for quick weight changes

\$1,965

#516116
l-108" w-37" h-88"



Abdominal/ Low Back Selector

Custom Colors See Page 1!

Call for shipping lead times on all selector equipment

Easily changes from abs to back with pop-pin

Adjustable chest/back pad ensures perfect form

Roller ankle pad secures lower leg position
200-lb weight stack with 5-year warranty

\$1,995

#516110
l-60" w-44" h-65"



Vertical Row

Custom Colors See Page 1!

Call for shipping lead times on all selector equipment

Great exercise to isolate upper back muscles

Adjustable seat and chest pad ensure proper positioning

High-density foam for maximum comfort

Comfortable, dual-position, oversized

rubber handles

220-lb weight stack with 5-year warranty

Front-loading weight stack for quick weight changes

\$1,845

#516107
l-57" w-38" h-80"

Selector Leg Curl & Extension

Custom Colors See Page 1!
 Call for shipping lead times on all selector equipment
 Super smooth, 200-lb. weight stack
 5-yr. warranty on weight stack
 Adjustable ankle pad

\$2,095
 #516114
 1-77" w-41" h-65"



Leg Extension

\$1,845

#516112
 1-68" w-41" h-65"

Custom Colors See Page 1!
 Call for shipping lead times on all selector equipment

Super smooth,
 200-lb. weight stack
 5-yr. warranty on weight stack

Leg Curl

\$1,845

#516113
 1-77" w-41" h-65"

Custom Colors See Page 1!
 Call for shipping lead times on all selector equipment

Super smooth,
 200-lb. weight stack

5-yr. warranty on weight stack



Selector Lower Body Equipment

Leg Press

Custom Colors See Page 1!

Adjustable starting position allows full range of motion

Super smooth, 400-lb. weight stack

\$2,595

#516111
l-63" w-48" h-65"

Call for shipping lead times on all selector equipment



Standing Calf

Custom Colors See Page 1!

Call for shipping lead times on all selector equipment

Isolates upper calf

Super smooth, 400-lb. weight stack

\$2,195

#516115
l-52" w-52" h-65"



Total Hip

Custom Colors See Page 1!

Exercises: Hip Abduction, Adduction, Flexion and Extension

Works hips, glutes, and hamstrings

5 position adjustable platform
250 degree adjustable Hip Pad
Ballet Bars

200lb weight stack

\$1,995

#516105
l-38" w-48" h-72"

Call for shipping lead times on all selector equipment

Full Circuit Package

BFS has created a full body, selectorized package to work every major muscle group.

Custom Colors See Page 1!

Call For Shipping Lead Times of Selector Equipment

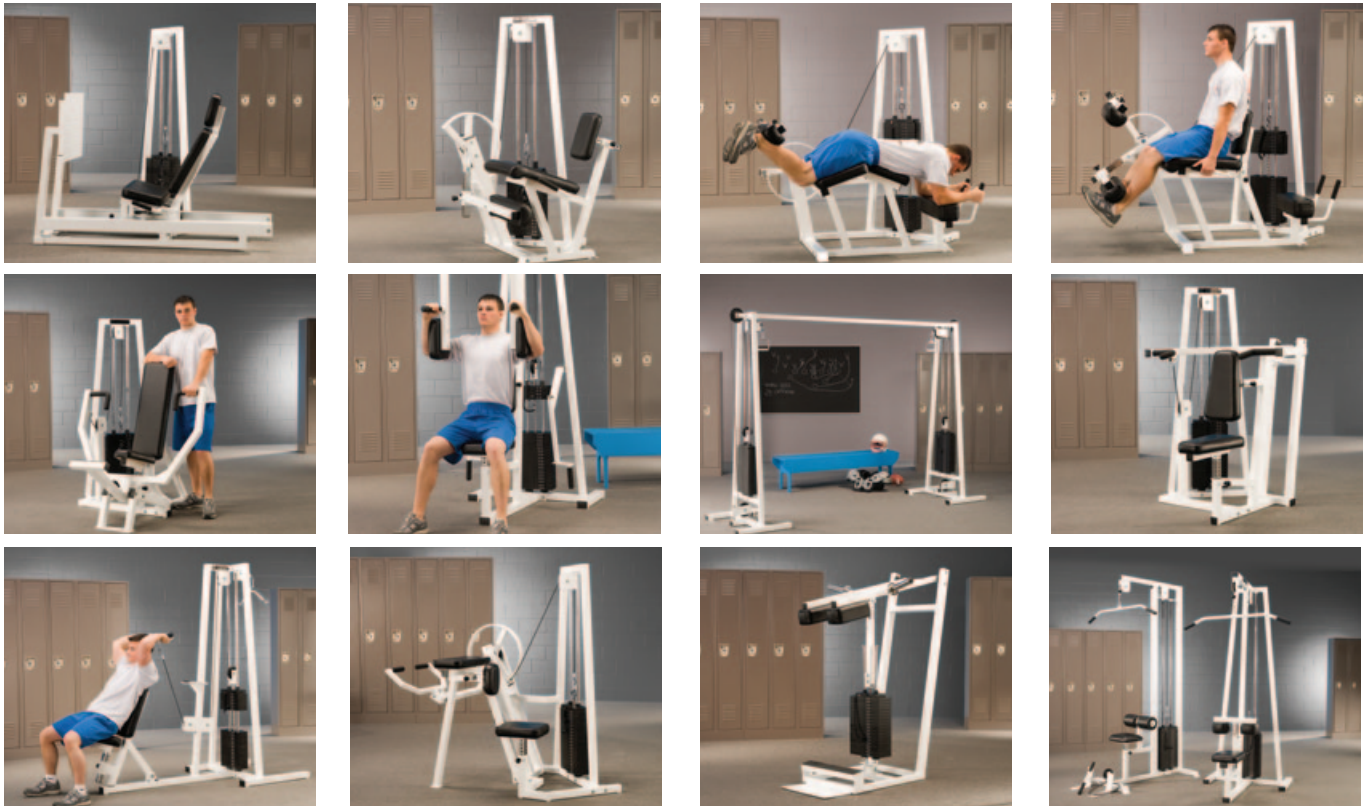

The package includes 12 of the following

(Maximum of 1 each):

- Vertical Chest Press
- Pec Dec/Rear Delt
- Military/Shoulder Press
- Elite Lat Pull
- Vertical Row

- Arm Curl
- Double Tricep
- Abdominal/Low Back
- Leg Press
- Leg Extension
- Leg Curl

- Standing Calf
- Standing Calf (plate loaded)
- Leg Curl/Extension
- Seated Row
- Assisted Chin Dip
- Total Hip

- Cable Crossover (counts as 1)
- Adjustable Cable Crossover (counts as 2)
- Functional Trainer (counts as 2)

Reinforced Nylon Pulleys



sealed ball bearings

Upholstery Selection

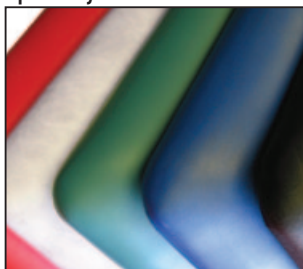

select a color that fits your style

19-Strand, 2000 lb Cable



nylon coated for years of use

Chromed Guide rods



appearance and durability

Ductile Steel Plates



steel/iron alloy won't break

Cam Driven Mechanism



smooth, consistent resistance

Powder Coated Paint Options



bright, durable color



Best value in selector equipment

Lifetime frame warranty

Ergonomically designed for maximum effectiveness

Constructed of 11-gauge steel tubing for years of durability

Durable high density pads

\$19,999 Plus Shipping

#616150

2 in 1 Selector

Multi-Chest Press

Custom Colors See Page 1!
Call for shipping lead times
on all selector equipment

\$2295

#519501
l-79" w-58" h-64"



Bicep/Tricep

Custom Colors See Page 1!

Call for shipping lead
times on all selector
equipment

\$2295

#519504
l-93" w-34" h-83



Leg Press/Calf Raise

Custom Colors See Page 1!
Call for shipping lead times on all
selector equipment.

\$2295

#519506
l-78" w-53" h-64"



Lat Pull/Vertical Row

Custom Colors See Page 1!
Call for shipping lead times on all
selector equipment.

\$2295

#519503
l-54" w-36" h-83"



Abdominal/ Low Back

Custom Colors See Page 1!
Call for shipping lead times
on all selector equipment.

\$2295

#519505
l-34" w-48" h-64"



Leg Extension Seated Leg Curl

Custom Colors See Page 1!
Call for shipping lead times
on all selector equipment

\$2295

#519502
l-53" w-49" h-64"



2-in-1 Selector Package

All 6 pieces

\$12,995

1 of each • Plus Shipping
#619500





Bicep/Tricep

\$1295

#525904 l-48" w-40" h-49"



Chest Press/Row

\$1295

#525901 l-48" w-46" h-53"



Vertical Row/Chest

\$1295

#525903 l-48" w-40" h-49"



Abdominal/Low Back

\$1295

#525908 l-48" w-40" h-60"



Shoulder Press/Lat Pull

\$1295

#525902 l-48" w-40" h-55"



Leg Extension-Curl

\$1295

#525906 l-48" w-40" h-47"



Ab/Ad Hip

\$1295

#525907 l-54" w-48" h-48"



Upright Row-Tricep

\$1295

#525909 l-84" w-46" h-60"



Squat Press

\$1295

#525905 l-84" w-46" h-60"

Custom Colors See Page 1!

Call for shipping lead times on all hydraulic equipment

Train Safe - Train Smart

**MIDDLE SCHOOL CIRCUIT
ALL 9 PIECES NOW ONLY**

\$10,995

plus shipping
Circuit Item #625900



Bicep/Tricep

\$675
#525806



Seated Row/Press

\$675
#525804



Chest Press/Vert Row

\$675
#525801



Leg Extension-Curl

\$675
#525808



Abdominal/Low Back

\$675
#525803



Shoulder Press/Lat Pull

\$675
#525802



Upright Row-Tricep

\$675
#525805



Squat Press

\$675
#525807



Custom Colors See Page 1!

Call for shipping lead times on all hydraulic equipment

Train Safe - Train Smart

ELEMENTARY SCHOOL CIRCUIT

ALL 9 PIECES NOW ONLY \$5,995

plus shipping
Circuit Item #625855

New Item!
Not Shown

3 in 1 - Chest /
Shoulder / Leg

\$1,145.00

525850

Set includes the combination 3 in 1 - Chest / Shoulder / Leg - not shown here

Economy Stadium DB Rack

\$395
#314058



Economy Dumbbell Racks

No Custom Options Available

3-Tier

Holds 5-65 lb. Hex Head Set

\$169

#340433
l-53" w-24" h-33"

2-Tier

Holds 5-50lb. Hex Head Set

\$149

#340432 (not shown)
l-50" w-18" h-26"



Heavy Duty 10 ft. 3-Tier Dumbbell Rack

Custom Colors See page 1!
Dumbbells not Included

\$745

#52849
l-120" w-18" h-32"

2-Tier Version

\$645

#52848 (not shown)



Heavy Duty 5ft. 3-Tier Dumbbell Rack

Custom Colors See Page 1!
Dumbbells not Included

\$515

#52847
l-55" w-18" h-32"

2-Tier Version

\$455

#52846 (not shown)

See more like these on Page 49



Absolute 5 Foot Dumbbell Rack

Custom Colors See Page 1

3-Tier

\$675

#5AB47
30" x 66" x 41.5"

2-Tier

\$555

#5AB46
(not shown)



Absolute 10 Foot Dumbbell Rack

Custom Colors See Page 1

3-Tier

\$995

#5AB49
30" x 128" x 41.5

2-Tier

\$875

#5AB48
(not shown)

Keep your weight room safe and orderly with storage designed to hold all your dumbbells



Heavy Duty Kettle Bell Rack

Custom Colors See Page 1

10' 3-Tier

\$795

#528633

10' 2-Tier

\$695

#528632

5' 3-Tier

\$565

#528643

5' 2-Tier

\$505

#528642

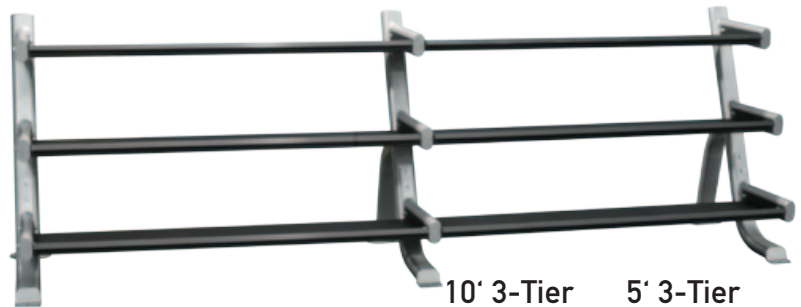

Absolute Kettle Bell Rack

Custom Colors See Page 1
Sleek modern design keeps your Kettle Bells neat and looks great in any weightroom

10' 3-Tier

\$1045

#5AB633

10' 2-Tier

\$925

#5AB632

5' 3-Tier

\$725

#5AB643

5' 2-Tier

\$605

#5AB642



A-Standard Plate Rack

\$165 #52843
l-32.5" w-24.5"
h-36.5"

B-Olympic Plate Rack

\$165 #52844
l-32.5" w-24.5"
h-36.5"

C-Plate Tree

\$335 #52862
l-26.5" w-20"
h-47.5"

D-Bumper Plate Rack

\$165 #52845
l-32.5" w-24.5"
h-36.5"



Horizontal Bumper Plate Rack

\$275 #52861
l-47" w-18" h-18"

Horizontal Plate Rack

\$275 #52860
l-41" w-18" h-18"



BXI 9 Bar Storage Rack

\$155
#5BX9VBS



5-Bar Vertical Rack

\$205 #52851
l-37" w-37" h-8"

5-Bar Horizontal Rack

\$325 #52850
l-24" w-31" h-49"



Economy Plate Rack

\$99 # 340444
l-32.5" w-24.5" h-36.5"



BXI Mobile Bumper Storage Rack

\$125
#5BXMBP



10 ft
\$695
#52865

Heavy Duty Kettle Bell/Dumbbell/Bumper Rack

Custom Colors See Page 1

5 ft
\$465
#52866



10 ft
\$945
#5AB65

Absolute Kettle Bell/Dumbbell/Bumper Rack

Custom Colors See Page 1

5 ft
\$625
#5AB66

BFS Olympic Sets

Top quality cast iron plates
Smooth machined edges without pits or holes and
precision weights on each plate

500 lb Set

1 - Olympic Bar	2 - 5 lb Plates
6 - 45 lb Plates	4 - 2.5 lb Plates
2 - 35 lb Plates	1 pr. - Mega Grip Collars
2 - 25 lb Plates	
4 - 10 lb Plates	

400 lb Set

1 - Olympic Bar	4 - 5 lb Plates
4 - 45 lb Plates	4 - 2.5 lb Plates
2 - 35 lb Plates	1 pr. - Mega Grip Collars
2 - 25 lb Plates	
2 - 10 lb Plates	

300 lb Set

1 - Olympic Bar	2 - 5 lb Plates
2 - 45 lb Plates	4 - 2.5 lb Plates
2 - 35 lb Plates	1 pr. - Mega Grip Collars
2 - 25 lb Plates	
2 - 10 lb Plates	

Ultra-Lite Bar (6 ft.)

\$145
#310072

Ultra-Lite Bar Set:

\$215
#312073

1 Ultra-Lite Bar

1 pr. 10 lb Bumper Plates

1 pr. Mega Grip Collars

An Olympic bar that weighs only 30 pounds
Great for teaching snatches and cleans
Fits on all standard-size racks and benches

TRAINING BAR



Aluma-Lite Bar (6 ft.)

\$155
#311005

Aluma-Lite Bar Set:

\$219
#312004

1 Aluma-Lite Bar

1 pr. 5 lb Training Plates

1 pr. Mega Grip Collars

An Olympic Bar that weighs only 15 pounds
A must for teaching snatches and cleans
2" Olympic rotating steel sleeves and light knurling on an aluminum shaft
Fits on all standard-size racks and benches

TRAINING BAR



BFS Olympic Sets

Top quality cast iron plates

Smooth machined edges without pits or holes and precision weights on each plate

Standard Olympic Bar

\$139

#340069

Standard Olympic Bar Sets

300lb set \$369

#312050

400lb set \$459

#312055

500lb set \$549

#312060

Our best value!
General-purpose bar
Yield strength: 105,000-125,000 PSI
Beautiful black oxide shaft and polished steel sleeves



Super Bar Black

\$159

#340071

Super Bar - Black Bar Sets

300lb set \$389

#312020

400lb set \$479

#312025

500lb set \$569

#312030

Our most popular bar!
Heavy-duty general-purpose bar
Yield strength: 135,000-165,000 PSI



Super Bar Zinc

\$169

#340042

Super Bar - Zinc Bar Sets

300lb set \$399

#312043

400lb set \$489

#312044

500lb set \$579

#312045

Same as the Black Super Bar, but with a rust-resistant silver zinc finish
Yield strength: 135,000-165,000 PSI
Perfect general-purpose Olympic bar for heavy training



Power Squat Bar

\$179

#340064

Power Squat Bar Sets

300lb set \$409

#312067

400lb set \$499

#312068

500lb set \$589

#312069

The perfect bar for power lifting exercises
Center knurling for no-slip squatting
Yield strength: 135,000-165,000 PSI



Pro-Elite Power Squat Bar

\$349

#320076

Pro-Elite Power Squat Bar Sets

300lb set \$579

#312016

400lb set \$669

#312017

500lb set \$759

#312018

Heavy-duty bar perfect for squatting
Center knurling for no-slip squatting
Yield strength: 185,000 PSI
Durable black oxide



Pro-Elite Silver Zinc Olympic Bar

\$359

#320080

Super Bar - Zinc Bar Sets

300lb set \$589

#312061

400lb set \$679

#312062

500lb set \$769

#312063

Designed for the strongest athletes
Yield strength: 185,000 PSI
Durable zinc finish
No center knurling



Original Hex Bar

The classic model
The best way to perform deadlifts and shrugs
Hex bar design offers greater stability than triangle design

Weighs 45 lbs with solid, 2" Olympic sleeves
Holds five 45 lb Slim-line plates with collars

\$119
#340181
sleeve 10"
26"x 25" inside dimension



High Hex Bar

Handles are 4" higher than original Hex Bar, to accommodate taller or bigger athletes
A must for basketball teams
Weighs 45 lbs with solid, 2"

Olympic sleeves
Holds five 45 lb Slim-line plates with collars

\$139
#340178
sleeve 10"
26"x 25" inside dimension

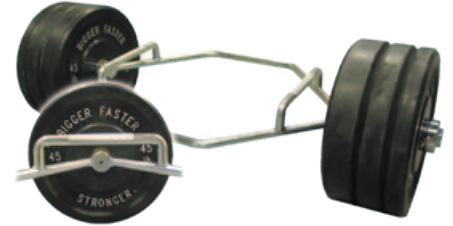

Combo Hex Bar

Combines the High-Hex and regular Hex bars in one bar
Simply flip over to change exercise starting position

Weighs 50 lbs with solid, 2" Olympic sleeves
Holds five 45 lb Slim-line plates with collars

\$169
#340179
sleeve 10"
26"x 25" inside dimension

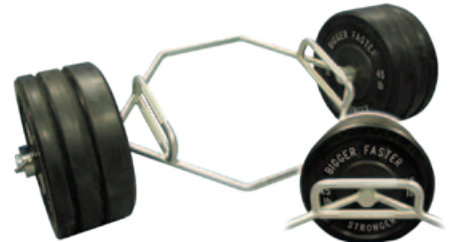

Mega Hex Bar

Built for the biggest and strongest athletes
Weighs 75 lbs
Solid, 2" Olympic sleeves and a thicker steel frame
Holds up to nine 45 lb Slim-line plates per side

Combines the High-Hex and regular Hex bars in one bar
Simply flip over to change exercise starting position

\$199
#340180
sleeve 15.5"
26"x 24" inside dimension



Youth Hex Bar

Great for teaching perfect technique
Weighs only 15 lbs
Slightly smaller in diameter with shorter sleeves

Ideal for rehab and upper body exercises
Used in the BFS Readiness Program

\$159
#320074
sleeve 9"
20"x 21" inside dimension



Curl Bar

Chrome finish
2" Rotating Sleeves

\$89
#310185



Heavy Duty Curl Bar

Chrome finish
Urethane grips

\$129
#310184



Tri-Trip Bar

\$129
#310182

Youth Training Bar

With 2 training plates

Learn perfect technique with no stress

\$15.95

#329073

Youth Training Bar Class Package

10 Bars with 20 Plates

\$99.95

#329074



Work Out Bars

Available individually or in money saving sets

314057A	Workout Bar - 5lbs	\$26.95
314057B	Workout Bar - 8lbs	\$28.95
314057C	Workout Bar - 10lbs	\$30.95
314057D	Workout Bar - 12lbs	\$32.95
314057E	Workout Bar - 15lbs	\$34.95
314057F	Workout Bar - 20lbs	\$36.95

314057RK	Workout Bar - Rack	\$299.00
314057ST	Full Set 1 of Each Bar	\$159.00
314057SR	Full Set & Rack 1 of Each Bar and Rack	\$419.00



Fixed Bar Sets

10 Bar Sets

Rack Included



Straight Bar Sets

\$2599

318193

25-115 lb. (10-bar set in 10 lb increments)



Curl Bar Sets

\$2499

318192

20-110 lb. (10-bar set in 10 lb increments)



Arm Blaster

Stabilizes the arms for a better workout

\$39

#320613

Lock Jaw Pro Collars

\$37/pr.
#320097P

Now with locking tab for securing the heaviest weights!



Mega Grip Collars:

Olympic Heavy Duty Collar

\$2195/pr.
#320096



Olympic Collar

\$1795/pr.
#320095

Extreme durability & tight hold!
Wider for an even greater hold!
Shark Skin Neoprene & Velcro
Construction with a Steel Ring Buckle



Lock Jaw Collars

\$34/pr.
#320097

Powerful lever action locks collar in place



Spring Lock Collars

\$1195/pr.
#320087

Quick and easy to use with plastic hand grip area



Muscle Clamps

\$33/pr.
#320246



Made of resin compound; more durable than plastic

Bulldog Collars

\$4995/pr.
#310183

Machined aluminum with a super tight hold.



Solid Rubber Bumpers



#320390	10 lb.	\$34.50 ea
#320391	15 lb.	\$44.50 ea
#320392	25 lb.	\$49.50 ea
#320393	35 lb.	\$59.50 ea
#320394	45 lb.	\$69.50 ea
#320395	Full Set	\$499

*(10 lb. Bumpers - Teaching Only Do Not Drop, Do Not Use With Iron Plates)

Black Crumb Bumpers



Pound Imperial Weights		
380390C	10 lb Black	\$25.00 ea
380391C	15 lb Black	\$35.00 ea
380392C	25 lb Black	\$40.00 ea
380393C	35 lb Black	\$50.00 ea
380394C	45 lb Black	\$60.00 ea
380396C	55 lb Black	\$70.00 ea
380395C	Full Set10 to 45lb	\$399.00
380397C	Full Set10 to 55lb	\$539.00

Kilogram Metric Weights		
380390KG	5 kg Black	\$28.00 ea
380391KG	10 kg Black	\$48.00 ea
380392KG	15 kg Black	\$58.00 ea
380393KG	20 kg Black	\$68.00 ea
380394KG	25 kg Black	\$78.00 ea
380395KG	Full Set 5 to 25kg	\$529.00

(10 lb. Bumpers - Teaching Only Do Not Drop, Do Not Use With Iron Plates)

Solid Colored Bumpers



#320386	10 lb.	\$49.50 ea
#320382	25 lb.	\$69.50 ea
#320383	35 lb.	\$99.50 ea
#320384	45 lb.	\$114.50 ea
#320387	Full Set	\$599.00
#320385	HD Set	\$529.00

HD Set includes pairs of 25, 35 and 45
Full Set includes pairs of 10, 25, 35 and 45

(10 lb. Bumpers - Teaching Only Do Not Drop, Do Not Use With Iron Plates)

Economy Colored Bumpers



349590	10lb GREEN	\$35 ea
349591	25lb YELLOW	\$45 ea
349592	35lb BLUE	\$65 ea
349593	45lb RED	\$85 ea
349594	Full Set	\$415

*(10 lb, Bumpers - Teaching Only Do Not Drop, Do Not Use With Iron Plates)

Rubber Rimmed Bumpers



#310325	25 lb.	\$54.50 ea
#310335	35 lb.	\$74.50 ea
#310345	45 lb.	\$89.50 ea
#310350	Full Set	\$429.00

Brightly colored bumper plates with a cast iron center and permanently attached rubber rims.

5lb. Training Plates

\$34.50 each

#320200
Teaching Only - Do Not Drop,
Do Not Use With Iron Plates



HiTech Plates

The most durable training plates made!

#380211	5 lb. pair	\$139
#380212	10 lb. pair	\$159



Deca Disc Training Plates

\$22.50 each

#320204
Teaching Only - Do Not Drop,
Do Not Use With Iron Plates



Solid Rubber, Steel Hub Colored Bumpers

Kilogram Metric Weights		
349680	10 KG GREEN	\$115.00 ea
349681	15 KG YELLOW	\$140.00 ea
349682	20 KG BLUE	\$165.00 ea
349683	25 KG RED	\$200.00 ea
349684	Full Set	\$1095.00
Pound Imperial Weights		
349690	25 LB GREEN	\$120.00 ea
349691	35 LB YELLOW	\$145.00 ea
349692	45 LB BLUE	\$170.00 ea
349693	55 LB RED	\$205.00 ea
349694	Full Set	\$1145.00

Iron Grip Plates (5 Hole)

\$1.49
Per Pound

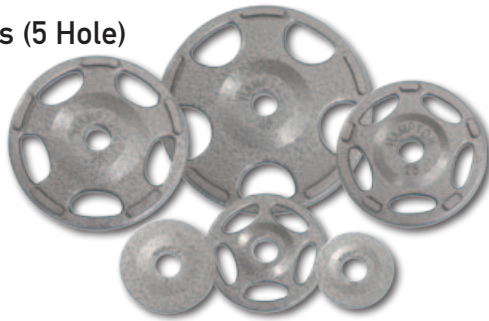

Rubber Grip Plates (5 Hole)

\$1.79
Per Pound



Rubber Grip Plates (3 Hole)

\$1.59
Per Pound



Dumbbells

\$1.19
Per Pound
Call for full set discounts
Highest durability
Comfortable grip

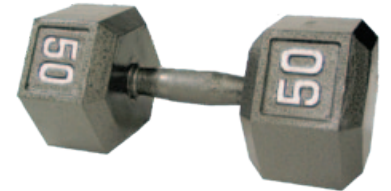

Slim Line Plates

\$1.09
Per Pound



Rubber-Encased Dumbbells

\$1.49
Per Pound
Call for full set discounts
Machined steel handles
Super tough, best quality rubber
Lowest price - Highest Quality

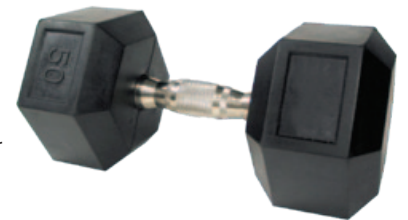

1.25 Pound Plates

\$2.25 each
340000



Neoprene - Covered Dumbbells

Neoprene-coated cast iron



\$1.39
Per Pound

CLUB PAK
INCLUDES
12 pair - 2 lb.
10 pair - 3 lbs.

Club Pack \$999
#318511

8 pair - 5 lbs.
7 pair - 8 lbs.
7 pair - 10 lbs.
1 Rack



Cast Iron Competition Kettlebell

349509	9 LB; WHITE	25.95 ea
349513	13 LB ; GRAY	34.95 ea
349518	18 LB ; PINK	43.95 ea
349526	26 LB ; BLUE	51.95 ea
349535	35 LB ; YELLOW	59.95 ea
349544	44 LB ; PURPLE	78.95 ea
349553	53 LB ; GREEN	95.95 ea
349562	62 LB ; ORANGE	107.95 ea
349570	70 LB ; RED	121.95 ea
349580	80 LB ; GRAY	139.95 ea
349588	88 LB ; WHITE	156.95 ea

KettleBells

#319410	10 lb	19.95 ea	#319440	40 lb	58.95 ea
#319415	15 lb	26.95 ea	#319445	45 lb	63.95 ea
#319420	20 lb	32.95 ea	#319450	50 lb	69.95 ea
#319425	25 lb	39.95 ea	#319460	60 lb	84.95 ea
#319430	30 lb	46.95 ea	#319470	70 lb	99.95 ea
#319435	35 lb	52.95 ea	#319480	80 lb	109.95 ea



ALL NEW FLOORING OPTIONS FROM MONDO & BFS

Call 800-628-9737 to learn more



RAMFLEX

The leading choice for weight applications. Non-porous marbled surface, uniform composition and hammered texture.

Solid homogenous rubber wear layer engineered to withstand heavy abuse from strength and conditioning areas

Non-porous surface requires no coating or finishes, elimination of odors and hygiene issues

Provides protection against heavy impact. Glued down installation eliminates chance of bacteria or mold growth



SPORT IMPACT

Demanding areas? Sport Impact is the premium weight resistant rubber flooring. The leading choice for weight rooms.

PERFORMANCE LAYER

Solid 3mm homogenous rubber wear layer engineered to withstand heavy abuse from strength and conditioning areas

Non-porous surface requires no coating or finishes elimination of odors and hygiene issues

IMPACT LAYER

Provides protection against heavy impact. Glued down installation eliminates chance of bacteria or mold growth

MONDO COMFORT & SAFETY

Class 1 fire code rating. Antibacterial and antimicrobial throughout minimizes the risks of staph infections (MRSA). Outstanding slip resistance, ADA compliant as per ASTM D2047

DURABILITY AND LIFE CYCLE COST

Unparalleled ease of maintenance • Engineered to withstand static loads such as heavy weights and cardio equipment • 10+ year life expectancy • 100% recyclable

BFS ROLLED FLOORING

As low as \$1.99/sq. ft. Call for details

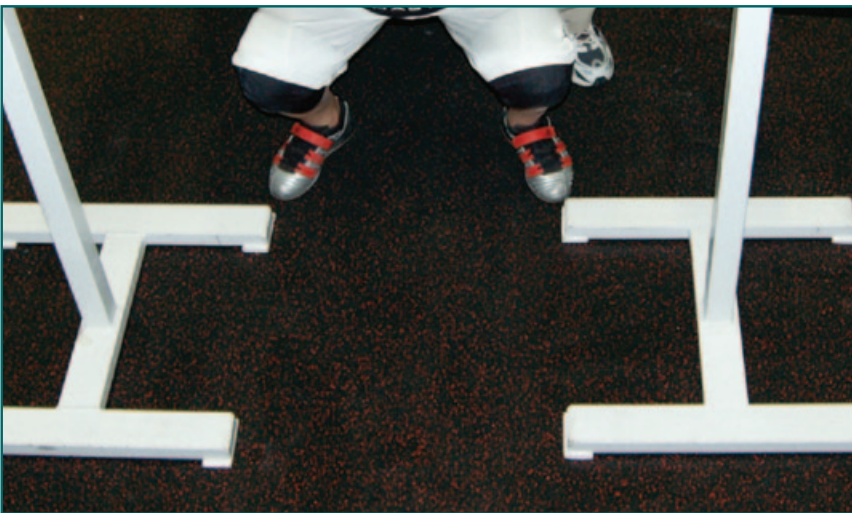

May cost less than 3/4" standard mats
 Custom cut to fit your room's dimensions
 Seamless appearance - lays like carpet
 Quick-ship option
 4 Feet wide by any length
 6mm and 8mm thickness
 10% to 20% color density option
 It's affordable
 It's sturdy enough to protect your floor

It's odorless
 It's easy and inexpensive to install
 Mats are not trued
 Call for pricing to true mats
CALL FOR CURRENT COLOR OPTIONS
800-628-9737



Numerous Color Options

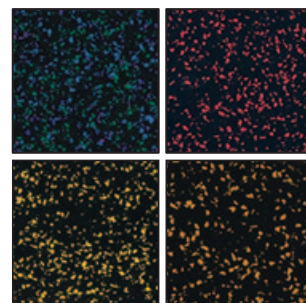

BFS Area Mats

Our most economical flooring option
 12 year warranty on 3/4" mats
 Mats are not trued
 Call for pricing to true mats

4'x6' x 1/2"
\$65ea.

#321004
 3 Yr. Warranty

4'x6' x 3/4"
\$75 ea.

#321003
 12 Yr. Warranty

Save on orders over 25 mats!
 Only \$2.59/sq. ft. on 1/2"
 Only \$2.99/sq. ft. on 3/4"

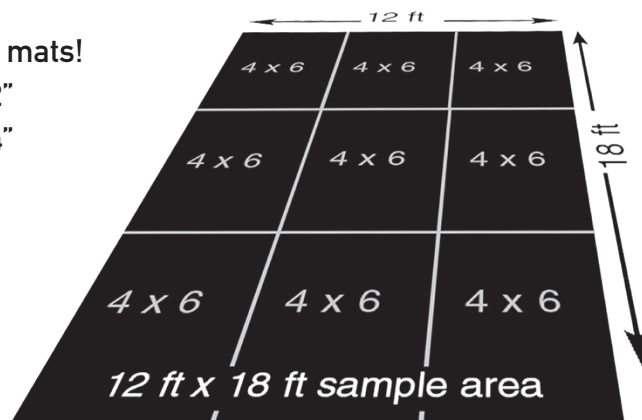

Power Clean Mats

4'x8'x1/2" Solid Mat

\$99

#321112

4'x8'x3/4" Solid Mat

\$149

#381114



25 ft. Rubber Roll

Perfect surface for plyos, sprinting and jumping!

\$279

#321122



Not recommended for full floor applications.
 For this purpose use BFS rolled flooring.



Star Trac S-TRx Treadmill

Call for Multi Unit / Discounted Pricing

User-friendly console and keypad feature a large service scrolling message window, user-specific workout programs, a dedicated heart rate display, Polar® telemetry.

Running Surface 60" x 20"

3 HP DC Motor

ELECTRICAL: 110 volt, dedicated NEMA 5-20 cord; 220 volt, dedicated NEMA 6-15 cord (optional)*

20" Belt

7" step-up height

User weight capacity 500 lbs (227 kg)

#328060

l-81" w-32" h-58"



Star Trac S-RBx Recumbent Bike

Call for Multi Unit / Discounted Pricing

Walk-through design - wrap-around seat adjust allow users to access and change seat position with ease

ELECTRICAL: Self-contained power supply, no external power needed. AC adapter is available for an upgrade

Dual-platform pedals with inline skate-style straps provide user with option for secure hold or strap-free platform workout

Star Trac's popular adjustable personal fans create a more rewarding workout

Contoured backrest for increased airflow and comfort

User weight capacity 350 lbs (159 kg)

#328062

l-66" w-28" h-53"

Star Trac S-CTx Cross Trainer

Call for Multi Unit / Discounted Pricing

User-friendly console and keypad feature a large service scrolling message window, user-specific workout programs, a dedicated heart rate display, Polar® telemetry.

ELECTRICAL: Self-contained power supply, no external power needed. AC adapter is available for an upgrade

Efficient footprint and approachable, stable platform with minimal step-up height for easy access from all angles

User weight capacity 350 lbs (159 kg)

#328061

l-76" w-64"

h-71.5"



Star Trac S-UBx Upright Bike

Call for Multi Unit / Discounted Pricing

User-friendly console and keypad feature a large service scrolling message window, user-specific workout programs, a dedicated heart rate display, Polar® telemetry.

ELECTRICAL: Self-contained power supply, no external power needed. AC adapter is available for an upgrade

Easy-up seat adjust for simple seat position changes

Star Trac's popular personal fan creates a more rewarding workout

All-steel frame is an approachable design that is rust resistant

User weight capacity 350 lbs (159 kg)

#328063

l-46" w-23" h-57"

**Surge 360
Floor Mount**

Space Saving Design!

\$1795

#BFSFM36A



Surge 360

Involve the whole body and utilize multi-joint movement for a superior cardio work out

\$1995

#BFS360A



Visit www.biggerfasterstronger.com
For indepth training information and
Surge 360 product info

Cardio Step

\$34.95

#314061

Space Saving Design

Step classes and cardio work are fun and easy for a variety of ages and strength levels. With adjustable heights this step is limited only by your imagination.

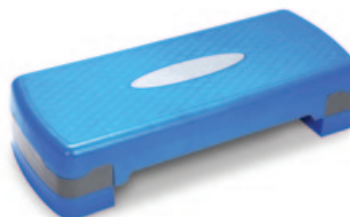

Super Tread

Massive - weighs 525 pounds!
User weight up to 600 pounds!
Huge 20" wide treadmill belt
40,000-mile rated deck and belt
Patented drive,
Elevation and shock absorption

10-year warranty on motor
3-years on parts ▪ **Lifetime guaranteed steel frame**

\$6,595

#323192 • Call for upgrade pricing

4600C FEATURES

5 Window LED displays Calories, METS (metabolic equivalents), watts, time, distance, incline and speed

4600CC FEATURES

All the features of the **4600C**, plus contact heart rate display

4600PR FEATURES

5-Window LED displays Calories, METS (metabolic equivalents), watts, time, distance, incline and speed

Dot matrix information display
Magnetic emergency "kill" switch
Countdown timer and security code

4600PRC FEATURES

All the features of the 4600PR, plus contact heart rate display

Gerkin Fitness Protocol available

4600HRT FEATURES

All the features of the 4600PR, plus contact heart rate display

Two polar telemetry controlled heart rate programs:

Weight Loss and Advanced Cardio
Gerkin Fitness Protocol available rate display

Sideline Cycle

\$1195

#383214

Maintain athletic readiness during games!

Commercial-grade drive belt for the smoothest ride

Proper warm-up and cool-down prevents muscle pulls

Heavy duty, solid steel frame handles up to 350 pounds

Fully-adjustable seats and handle bars

Electro-powder coated frame resists rusting and scratching

"Quick stop" safety system

Color and Model of bike may change based on manufacturer's supplies



Indoor Cycle 1

\$565

314062

Maintain athletic readiness during games!

Great for cardio work as well as warm ups and cool downs.

Variable resistance and size adjustments.

Color and Model of bike may change based on manufacturer's supplies



Indoor Cycle 2

\$345

#314063

Maintain athletic readiness during games!

This bike has all the features you need whether for rehab, warm ups or cool downs. Affordable cardio for you your team!

Color and Model of bike may change based on manufacturer's supplies



Rowing Machine

\$799

#314054

Space Saving Design

Involve the whole body and multi-joint movement for a superior cardio work out



BFS Plyo Boxes are the safest on the market

BFS Plyo Boxes Non-BFS Plyo Boxes

Boxes easily stack for storage



Varsity Plyo Box Set With Plyo Box Jumping Video

Three 20" boxes
 One 32" box with booster
 Plyo box jumping video

Varsity Set Features:

Nailed, screwed and glued together
 Made of 3/4" plywood
 3/8" solid, non-slip rubber tops
 Call for custom colors

\$695
 #651256



Individual Plyo Boxes

Call for custom colors



\$259
 #551269
 42" Box

\$219
 #551268
 32" Box

\$139
 #551267
 20" Box

\$119
 #551266
 10" Box

Booster Plyo Boxes

Small Booster
\$129
 551254

Med. Booster
\$139
 551253

Large Booster
\$149
 551252

No booster available for 42" box

Readiness Plyo Box Set

Shown in custom, call for custom colors
 Great for beginners
 Three 10" boxes
 One 20" box with booster
 Includes plyo box jumping video

\$595
 Stock Price (Black Paint)
 #651261

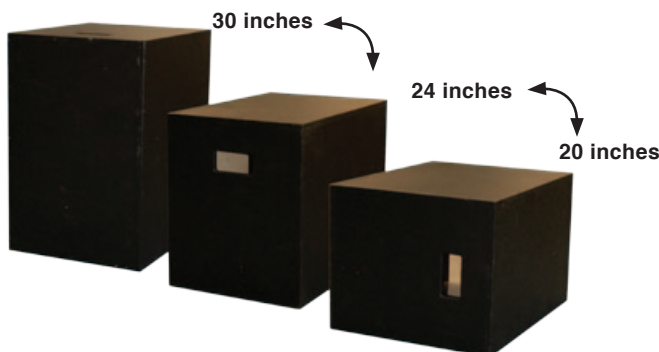

Plyo Max 3

\$169
 #551265

One Box - 3 heights!
 One box, maximum versatility
 Flip for 3 height options, 20, 24 and 30 inches
 Solid sided construction
 Call for custom colors



BFS Dot Drill

Use indoors and outdoors
Fully integrated dots — not just stuck on or painted

\$49

#321040
3' x 4' x 3/8"



FRONT TO BACK



QUARTER EAGLE



Plyo Ramp

Custom Colors See Page 1!
Develop explosive lateral quickness
Rehab tool for ankles and knees
Stable steel frame; non-slip rubber top
Includes plyo ramp video

\$495

#551270
1-89" w-48" h-14"

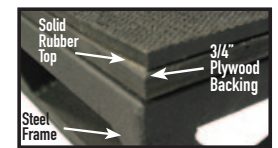

DURABLE CONSTRUCTION



UPPER BODY PLYO



LOWER BODY PLYO



Plyo Bar

Custom Colors See Page 1!
Sturdy adjustable bar height from 23" to 39"
Great for beginner's & advanced athletes
Challenging anaerobic exercise
Dozens of sport specific exercises in one station
Finally something new in plyometrics

\$1145

#65164
1-77" w-100" h-23"



Verti-Block Package - 12 Blocks

Our newest youth speed and agility training product!
Our goal is to increase your vertical jump, improve explosive power, as well as speed and agility, regardless of the level of fitness you are currently in now. Our Verti-block is designed to meet these goals in a safe, fun and affordable way.

\$549

#323275



BFS TEAMS WITH TECHNOLOGY LEADER OPTOJUMP

One meter system runs the BFS Protocol
Includes 2 Cameras and Tripods and 2, 1 meter skis
Quick accurate vertical jump
Computer not included



Balanced Training - BFS and Optojump

SYMMETRY/FOUNDATION
OPTIMAL PERFORMANCE

- ABILITY/STABILITY
- INJURY PREVENTION

OPTOJUMP
1 Meter System:

\$5895

#323279

Includes software support package with free software upgrades for the life of the product as well as technical support - 3 year warranty

OPTOJUMP MAKES IT POSSIBLE TO:

Assess performance and physical condition

Rapidly identify imbalances

Develop program specific training based on the test results

Periodically check the results and the effectiveness of treatment



5 and 10 Meter Systems Now Available
Call for Pricing
Includes software support package with free software upgrades for the life of the product - 3 year warranty

Just Jump & Run

The essential jump, plyometric, and speed testing tool with exclusive new BFS plyometric features!

Computerized system and platform

Measures vertical jump, foot quickness, reaction time, sprints

Voice activated and accurate up to .01 seconds,

Easily test 40+ athlete's vertical jump in 10 minutes or less

\$599

#324040

Fast & Accurate Vertical Jump



Air Time **.67 21.7**

IT'S SO SIMPLE! Just step on the pad and jump! The vertical jump is displayed in inches. And instantly the unit is ready for the next athlete! Super quick & easy!

V.J.in Inches

Sprint Time **.67 21.7**

Voice activated: timer starts when the coach yells "go" or whistle blows. Stops when pad is reached. Reads out to 1/100 of a second.

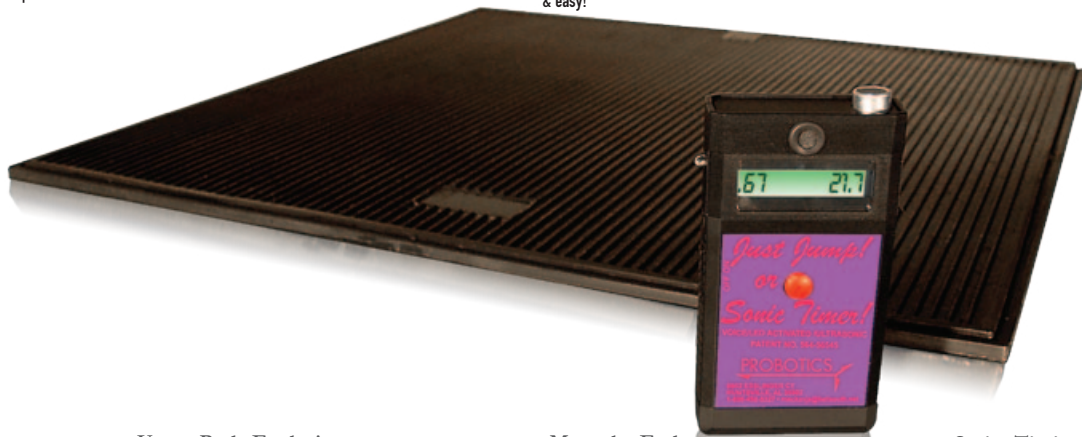

Depth Jump

Upper Body Explosiveness

Muscular Endurance

Sprint Timing



Agility Timer

\$899
#324038

Kit Includes:

- Agility Timer box unit
- One (1) reflector (for use on tripod)
- Two adjustable tripods (one for sensor box and one for reflector)
- Operating manual and test procedures



Fast, accurate and easy measurement of the "Pro Shuttle" drill!

The Agility Timer was designed to measure lateral agility. Agility refers to the ability to change directions rapidly while maintaining balance without the loss of speed. Collects two (2) times - Perfect for measuring Lateral Speed. Times to 1000th of a second (.000 decimal)



WITTY Timer

The compact size makes the Witty timer practical and easy to use in the field. The Witty's wireless transmission allows coaches to move around the training field to provide immediate feedback to athletes. The timer comes with a variety of preconfigured tests (sprint, shuttle, endurance, course), it also allows the trainer to set sport specific customized tests. Witty may be used in combination with the OptoJump Next system. The photocells give the external start impulse and to stop the test & recording intermediate times during the sprint/run test.

\$1,950
#323276

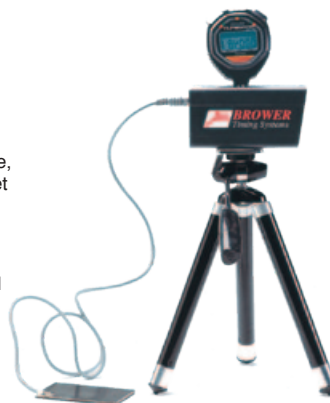

Speed Trap 1

Infrared beam times distances up to 50 yards. Accurate to .01 sec. Use indoors or outdoors. Starting pad can be used with hand or foot

\$549
#324031



30' Ballistic Response Ladder

\$59⁹⁵
#323266
Our #1 speed training product!
Improve linear and lateral movement and foot quickness
Develops change-of-direction skills
10 yards long, 20 rungs
Storage bag and training manual

Also Available:
15' Ballistic Response Ladder

\$39⁹⁵
#323264

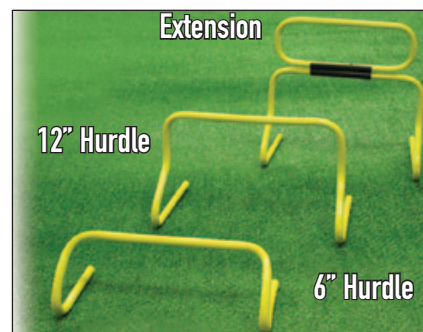

Performance Hurdles

#323268	6" Hurdle	\$8.50
#323267	12" Hurdle	\$8.95
#323269	Extension	\$5.99

HURDLE EXTENSIONS:
Snap-on hurdle extension
Increases height of hurdles by 6 inches!
Save 10 percent when ordering six or more

Teaches proper leg recovery and force application
Increases power and improves running technique

**Heavy Duty
BFS Push/Pull Sled**

Heavy 11 Gauge Steel Tubing
Durable 3/8" Solid Steel Slide Plates
2 times as long lasting as aluminum
Built to be used on concrete or asphalt or any hard surface
High Vertical Handles & Low Horizontal handles
Pull Harness attachment position
Dual Olympic Plate Holders
Develop explosive power in LEGS
and HIPS

\$295

551451
Harness and Bumpers not Included

\$345

651451A
With Harness and Lead



Sled Includes "D" clip for attaching a harness (Not Shown)

Sprint Sled

Improves power
2" Olympic plate holder
Comfortable, yet durable, nylon
harness and lead

\$199

#551450



D Flex

The D Flex will give you a kinesthetic feel of how to keep your toes up as you sprint!

Includes a manual of training protocols (download at www.biggerfasterstronger.com)

\$69

#325165



Speed Harness

Recommended for sprints of less than 30 yards

Neoprene and PVC handle; easy to use and durable

\$4995

#323129



**Doubleman
Overspeed**

Cord safely contained in nylon sleeve

\$10995

#325155



Giant Sprint Chute

\$8995

#323200

Large Sprint Chute

\$7995

#323203

Medium Sprint Chute

\$7595

#323202

Small Sprint Chute

\$6995

#323201



Specifically designed to increase speed
Strong, inner-core webbing
Quick-release belt



Harness & Lead

Comfortable, yet durable, nylon harness and lead

\$4995

#323130



Instruction book and DVDs available online

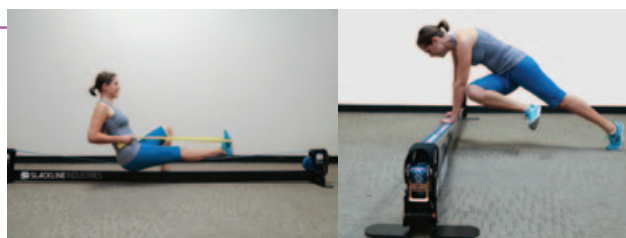

Slack Line Fitness Stand (10 ft)

The Slackstand is a completely freestanding, portable structure allowing set-up indoors or out without the need for trees or other anchors. The Fitness Slackstand includes a 12 foot slackline, elastic workout band and a workout poster to help guide you through some exercises. Steel construction provides a solid base and sleek design keeps the unit as lightweight and compact as possible. Easy to assemble and it also breaks down into two sections for convenient storage.

\$324.99

#325504



Slack Line Base Line (50 feet)

This versatile 2-inch style slackline designed as an easy-to-use kit with slackline specific webbing appeals to all levels of users. The thick weave makes it ideal for walking or getting started with tricks. Available in two lengths, 50 or 85 feet.

\$74.99

#325500

Line 85 feet

\$89.99

#325501



Slack Line e Line

The YogaSlackers eLine is a low-stretch slackline that sets up easily with a simple closed-loop system. Little to no effort is required to tension it so anyone can do it in just a few minutes. Get in touch with the roots of slacklining using this traditional kit.

\$89.99

#325503



Slack Line Fitness Line (50 feet)

The Fitness Line makes it easy to incorporate slackline resistance training into any workout routine. The simple, two-piece setup is designed to enhance traditional exercises, strengthen core muscles and hone balance skills. The included stretch band and workout guide offer a full body resistance training program.

\$79.99

#325502



Slack Line Tree Pro

Protecting trees and the slackline is important and responsible etiquette for setting up at home or in public places. Treepro makes it easy with Velcro closures to simply wrap the tree prior to setting up the slackline. The padded felt ensures trees are

safe and prevents fraying of the line. Set includes two pieces- one for each anchor.

\$19.99

#325505



Slack Stand Hanger

The Slackstand Hanger is the perfect solution for storing your Slackstand when not in use. Simply mount the hanger using the included bolts to studs in the wall. For use in gyms, fitness clubs, schools and even right at home.

\$39.99

#325506



Jump Rope Cord

\$8.99

314052



Jump Rope Beaded

\$10.95

#323150



HD Harness

\$99.95

Small #323500S

Med #323500M

Lrg #323500L

XL #323500XL



Weight Vest

Adjustable Weighted Vest - 20 lbs

\$69.95

#314055

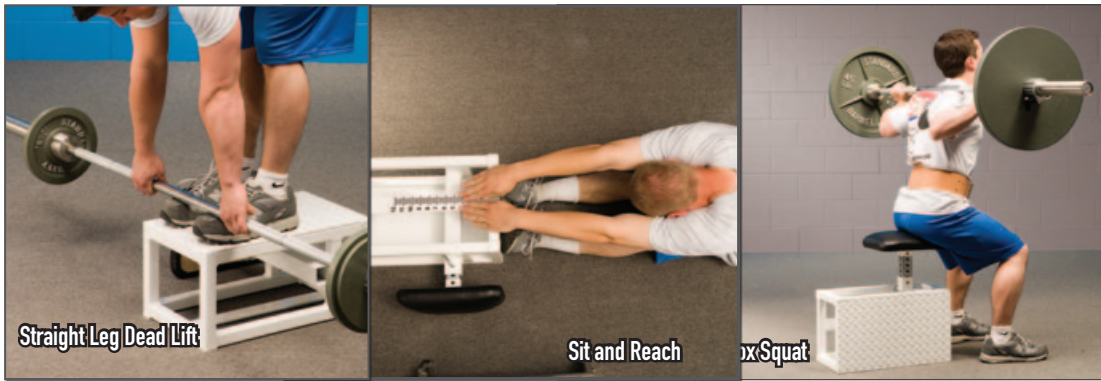

3-in-1 Squat Box

Pick your color, see page 1

\$295

554447



True Squat

Coming Soon

Measure your squat to ensure you are getting the optimal results from your training!

Visit www.biggerfasterstronger.com to learn more about this app for your phone or portable device.



Bench Block

The Towel Bench Press is a core lift in the BFS Total Program and this innovative bench block makes it quicker, cleaner and safer to run multiple athletes through a Towel Bench workout.

\$24.95

324030

Full Set of Chains

One pair of each size
Dramatically improve explosive strength!
Shatter personal records!
Challenging, motivational and fun!
Heavy duty: Built to last a lifetime

Easy to use: Attaches to barbell sleeves like a collar

\$599

#65474

Varsity Pair of Chains

\$169

#55467

Recommendation: Bench 200 lbs. or less • Squat 300 lbs. or less

Each chain weighs approx 12 lbs.u

All State Pair of Chains

\$199

#55468

Recommendation: Bench 200-300 lbs. • Squat 300-400 lbs.

Each chain weighs approx 19 lbs

All American Pair of Chains

\$249

#55469

Recommendation: Bench over 300 lbs. • Squat over 400 lbs.

Each chain weighs approx 28 lbs.

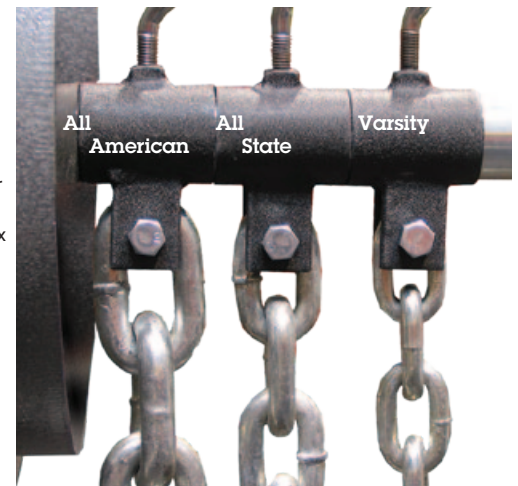

Chain Extenders

\$69

Extends chains by 2 feet to prevent swinging during overhead lifts

Increases resistance at finish of lift. Great for squats!

Manta Ray

\$44.95

#324029



Barbell Pad

\$12.95

#320107



Squat Box

Thousands sold!

554244 \$89 Low (for heavy squats)

554240 \$99 Short (under 5'8")

554245 \$109 Med. (5'8"to 6'1")

554250 \$119 Tall (6'1"to 6'6")

554255 \$129 X-Tall (over 6'6")

Power Clean Blocks

3/4" plywood construction
Rubber tops and rubber lip to prevent rolling

\$159

#554241



Towel Bench Pad

\$12.95

#320154

A BFS core lift



Squat Box Booster

\$89

320251

Resistance Bands

1. Purple Mini	1/2 Inch	#315050	\$9.00
2. Red Super Mini	13/16 Inch	#315051	\$13.50
3. Blue Small	1 1/8 Inch	#315052	\$18.00
4. Green Medium	1 3/5 Inch	#315053	\$22.50



Resistance Bands Sets

315057	Readiness Band Set Pairs 1, 2, 3	\$75.00 Save \$6.00
315058	Varsity Band Set Pairs 1, 2, 3, 4	\$115.00 Save \$11.00
315059	Elite Band Set Pairs 1, 2, 3, 4, 5	\$160.00 Save \$20.00
315060	D1 Band Set Pairs 1, 2, 3, 4, 5, 6	\$230.00 Save \$34.00
315061	Pro Band Set Pairs 1, 2, 3, 4, 5, 6, 7	\$315.00 Save \$54.00

Medicine Balls

Thick, durable rubber shells



323141	2 lb Ball-Teal	\$15.95
323142	4 lb Ball-Purple	\$23.95
323143	6 lb Ball-Blue	\$31.95

323144	8 lb Ball-Yellow	\$39.95
323145	10 lb Ball-Red	\$44.95
323146	12 lb Ball-Gray	\$51.95

6-Ball Full Set & Rack

\$249
#323149



6-Ball Rack

\$69
#340086



Voodoo Band
Perfect for stretching and dynamic warm ups!

\$19⁹⁵
#315062

BulletProof Slam Balls



325450	4lb	\$94.99
325451	6lb	\$99.99
325452	8lb	\$104.99
325453	10lb	\$109.99
325454	12lb	\$114.99
325455	14lb	\$119.99

325456	16lb	\$124.90
325457	18lb	\$129.99
325458	20lb	\$134.99
325459	25lb	\$139.99
325460	30lb	\$144.99
325461	Full Set 1 ea	\$1,195.00



20 lb Fuel Ball
\$39.95
#314053

Rotational Body Weight Training

\$249.99
#323273



Fuel Pureformance Muscle Band



349400	0.5-Inch	5-50Pounds	10.95ea
349401	1.0-Inch	20-70Pounds	18.95ea
349402	1.75-Inch	50-120Pounds	29.95ea
349403	2.5-Inch	60-150Pounds	43.95ea



MCore
Versatile fitness station and more
Full body workouts
Additional MCore products and training info online

\$749.99
#BFBNCHA



Tru Fit - The Unit 2
Use with any BFS Rack!
When you purchase the UNIT™ you are getting the best. The UNIT 2.0 is the first, and last, multi-functional fitness product you'll ever have to buy.

\$199
Orange #323274OR
Electric Blue # 323274BL



ISO Balls
\$22
55cm #340089
\$26
65cm #340090



Sit & Reach Box
-6 inches to + 12 inches
3/4" plywood construction
\$119
#554262



Straight Leg Dead Lift Platform
Diamond tread, non-slip surface • Solid steel frame
\$139
#554449



Ab Wheel
\$16.95
#314059



Battle Rope
\$119
40' length, 1.5" diameter
25 lbs.
#314050



Fitness Mat
\$25⁹⁵
#314060

Cable Attachment Handles

Chromed Bars and Handles with Urethane Grips



A.	36" Lat Bar	#310169	\$45
B.	34" Pro-Style Lat Bar	#310173	\$59
C.	48" Revolving Lat Bar	#310171	\$57
D.	Dual Action Chain Stirrup Handle	#310175	\$59
E.	Tricep Press Down Bar	#310161	\$30
F.	Seated Row / Chinning Bar	#310160	\$33
G.	20" Cable Bar	#310168	\$31
H.	Deluxe Stirrup	#310163	\$27
I.	Single Palm Grip Handle	#310176	\$25
J.	28" Revolving Curl Bar	#310170	\$45
K.	Multi-Exercise Bar	#310158	\$54
L.	Leather Tricep	#327117	\$54
M.	Tricep Rope	#310165	\$26
N.	Leather Ankle Strap	#323123	\$28
O.	Nylon Ankle Strap	#322922	\$13

Accessories - Belts

EXCLUSIVE BELT COLOR CODED SIZING SYSTEM FROM BFS

Made of 1/4" top-grain leather & steel buckles and designed for the toughest environments.

4" Belt- Color Coded		6" Belt - Color Coded		Power Belt Color Coded		Waist Size Chart	
XS, S, M, L	\$27.95	XS, S, M, L	\$32.95	XS, S, M, L	\$36.95	X-Small	22"-33"
X-Large	\$32.95	X-Large	\$37.95	X-Large	\$42.95	Small	25"-36"
XX-Large	\$37.95	XX-Large	\$43.95	XX-Large	\$48.95	Medium	28"-41"
XXX-Large	\$44.95	XXX-Large	\$49.95	XXX-Large	\$54.95	Large	33"-44"
						X-Large	38"-47"
						XX-Large	43"-52"
						XXX-Large	49"-55"

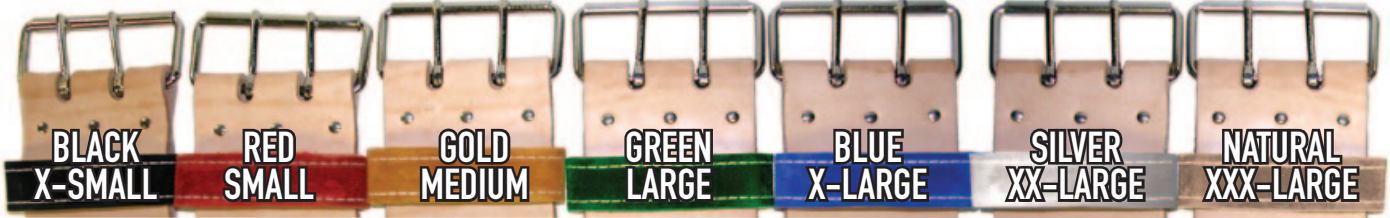

BFS Flex Belts

The color of belts varies based on manufacturer's Stock; Black is the most available color



Belt Size	Waist Size	5 inch Flex \$ 40.00	Power Flex \$ 44.00
X-Small	22 – 28 inches	323103XS	323104XS
Small	26 – 32 inches	323103S	323104S
Medium	30 – 36 inches	323103M	323104M
Large	34 – 40 inches	323103L	323104L
X - Large	38 – 44 inches	323103XL	323104XL
XX - Large	42 – 48 inches	323103XXL	323104XXL
Custom Lettering: Per Belt		\$25.00	383104
Must be used w/ Product #s 323103 & 323104			

4" and 6" Nylon Belt

Nylon belt with steel buckle and Velcro® closure.

Nylon Belt	4 inch - \$ 25.95	6 inch - \$ 29.95
Small	322910	322915
Medium	322911	322916
Large	322912	322917
X - Large	322913	322918



Nylon Dip Belt

\$3495
#322920



Dip Belt

\$47
#323105



Belt Rack

Safe and stable steel frame
Lockable — Protect your investment!
Use the BFS Belt Rack to store your chains

\$159
#554435





Hand Armor Liquid Chalk
 Hand Armor Liquid Chalk is the handy, no mess solution for a variety of sports and training situations. Hand Armor comes in a variety of sizes from personal use to institutional uses. Keep your grip with Hand Armor!

Superior Grip Performance, Superior Protection

1. Antibacterial- Kills 99.9% germs and bacteria like Staph, H1N1, MRSA, Ringworm, etc.
2. Last up to 10 times longer than regular chalk.
3. Not messy like regular chalk.

4. Prevents blisters and tears due to "drying" agent.
5. Much more cost effective than regular chalk.

2 oz	#388700	\$4.95
4 oz	#388701	\$8.95
8 oz	#388702	\$14.95
16 oz	#388703	\$24.95
32 oz	#388704	\$44.95



Chalk Ball
\$6⁹⁹
 #320099



Gym Chalk
\$11⁹⁵
 #320104



Chalk Bin
\$79
 #324010



Plate Loaded Gripper
\$169
 #554452



Gripper
\$37⁹⁹
 #320086



Fat Gripper
\$44⁹⁵
 #320152



Wrist Roller
\$19⁹⁵
 #320625



Hand Grip
\$13⁹⁵
 #314056



Custom Championship Weight Room Banners

Large 5' X 3' Banners

Customize your banner with your school or team name to inspire athletes and students to strive to be thier absolute best!

\$199

Custom #900BNR
 Call For Custom Color Options 800-628-9737



Custom Record Boards

Large 8' X 3.5' Boards

Moveable name tags with custom colors
 Add your school or team name
 Choose your 10 Categories

\$1249

#325116

DRY-ERASE NAME TAGS ARE VELCRO BACKED FOR EASY REARRANGING AND UPDATING AS YOUR ATHLETES IMPROVE!



Depth Chart & Top 5 Boards

4' X 3.5' Boards

\$699

Custom 325118
 Call For Custom Color Options 800-628-9737



Quick Wraps
\$1195
 Black
 #320505



Tiger Tail
 Muscle Recovery System
 Smooth Rolling
\$3299 **\$2799**
 22 inch #326011 18 inch #326010

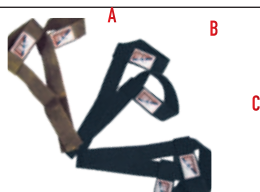

Sure Grip Straps
\$995
 A. Leather - #322927 \$10.95pr
 B. Cotton - #322925 \$7.95pr
 C. Padded - #322926 \$9.95pr



Knotty Tiger
 Muscle Recovery System
 Release knots in tight areas
\$1899
 #326012



Lifting Hooks
 Deadlifts, shrugs, rows
 Forged steel hook in heavyweight
 cordura nylon
\$2595
 #322928

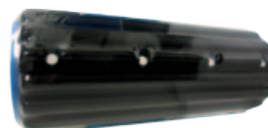

Extreme Roller
 Muscle Recovery System
\$3995
 #314051



Elastic Knee Wraps
\$1995
 #322932



BFS Back Pack
\$999
 #950BCKPCK



**Power Lifting
 Knee Wraps**
\$2895
 #322933



BFS Water Bottle
\$599
 #950WTBT



Elastic Elbow Wraps
\$1595
 #322934



BFS Wrist Bands
\$699
 #950WRBD



Elastic Wrist Wraps
\$995
 #322931



BFS Head Band
\$799
 #950HDBD



Neck Harness
 Leather Nylon
\$45 **\$2695**
 #323115 #322921



BFS Hand Towel
\$699
 #950TWL



Leather Gloves
\$1695
 XS 322945 L 322948
 S 322946 XL 322949
 M 322947 XXL 322950



BFS Dog Tag
\$499
 #950DGTG



BFS Lanyard
\$499
 #950LNYD

Safety Package

\$149
325077

Now With Six "Absolute" Posters & The "Safety & Liability Manual"

Prepare yourself with the information you need as a coach or administrator to avoid and/or win lawsuits that deal with the weight room.

- Implementation Instructions
- Weight Room Safety DVD
- Weight Room Rules Poster
- 1 Year Magazine Subscription
- Student/Athlete Acknowledgement Form
- Safety Posters, Training Posters



Total Program Package

\$99
#325187

- BFS Total Program Video
- Exercise Instruction DVD
- Bigger Faster Stronger Book
- Set-Rep Log Book
- Record Card
- Be an 11 Manual
- 1 Year Magazine Subscription



Women's Total Program Package

\$89
#325139

- Total Program for Women Video
- Exercise Instruction DVD
- Bigger Faster Stronger Book
- Womens' Set-Rep Log Book
- Record Card
- Be an 11 Manual
- 1 Year Magazine Subscription



Readiness Program Package

\$79
#325189

- Readiness Video
- Exercise Instruction DVD
- Bigger Faster Stronger Book
- Readiness Log Book
- Readiness Card
- Be an 11 Manual
- 1 Year Magazine Subscription



BFS Clothing Line Exclusively online at the BFS eStore

Certified Coaches line Now Available

www.biggerfasterstronger.com

- Coaches
- Athletes
- Training
- Gameday
- Casual



Scan Code to visit BFS Clothing Page



BFS Total Program Book

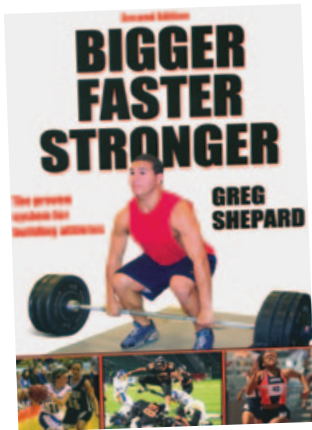

\$14⁹⁵
#325020

Be an 11 Guidebook for Success

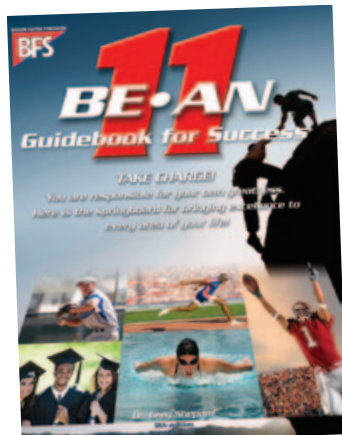

\$13⁹⁵
#325053

Dream the Biggest Dream

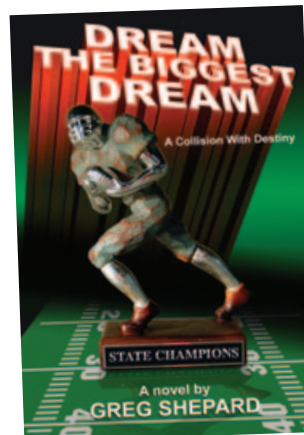

\$12⁹⁵
#325021

Magazine Subscription



\$19⁹⁵ \$34⁹⁵ \$49⁹⁵
1 year 2 years 3 years
080001 080002 080003

BFS Set-Rep Log Book



#325060

Women's Set-Rep Log Book



#325040

Readiness Log Book



#325050

BFS Log Book Pricing

1 Book \$5.00 ea.
2-19 Books: \$4.00 ea.
20-or More \$3.00 ea.



CUSTOM LOG BOOKS
\$4.50 each
(50 minimum)

BFS set rep cards, books and videos are Trademarked Products. It is illegal to reproduce these items in full or in partial form.

ALL NEW 48 page Flexibility Manual

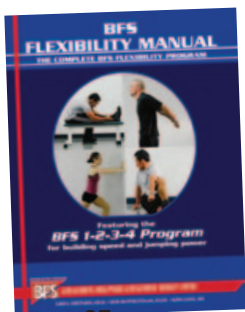

\$9⁹⁵
#325035

Record Cards



99¢
#325061BK
Black Only

Readiness Cards

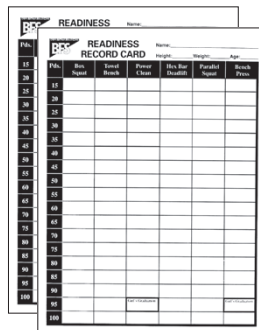

75¢
#325062BK
Black Only

Jumping Into Plyometrics

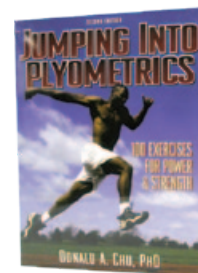

\$19⁹⁵
#325016

Dark Side of Sports



\$9⁹⁵
#325201

BEAT THE COMPUTER PRO®

Create personalized, sport-specific workouts using the most successful Set-Rep Computer Software Program ever created.

Print test sheets & forms

Athletes fill in forms listing core & auxiliary lifts.



Enter the Athlete's lifts
BTC Pro calculates weights for each set in a unique, sport-specific workout.

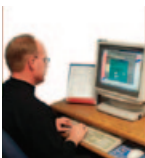

Each week simply print out the Weekly Workout Schedule for each athlete.



PRODUCE CUSTOMIZED ADDITIONAL REPORTS
Ironman & Power Rankings
Compare to national standards
Produce Top 10 Lists and Challenge your athletes to improve

\$299
#325091

PRINT TEST SHEETS GENERATE INDIVIDUAL WORKOUTS

Want to get started now? Download your **FREE 30 Day Trial** at www.biggerfasterstronger.com!

Each program is customized with the school name and CANNOT BE RETURNED. Please get the demo version if you are unsure of your purchase. Demos are available via download from biggerfasterstronger.com or call BFS. System Requirements:
Pentium II Mhz or faster processor • Windows 98, ME, XP, NT, 4, 2000 or newer operating system
256 MB or more of available memory (RAM) • 8x speed or faster CD rom (only required to install from CD)
Hard drive with 50 MB or more free space • SVGA monitor running at 800x600 resolution (1024x768 preferred), 256 color
Windows compatible mouse or other pointing device • Windows compatible printer.

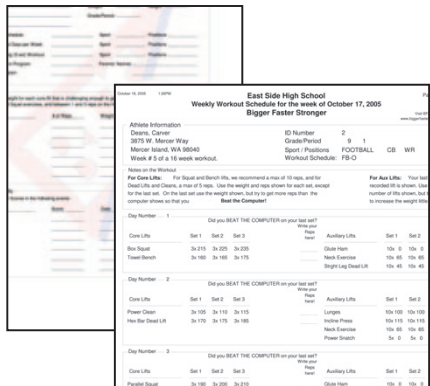

Coaching Youth Football Series

with Jeff Scurran
This DVD set is designed to help a coach on any level of Youth

Football understand how to organize their practice, get more out of their limited preparation time

in all aspects of the game. See results that will pay off in game situations.

Youth Football 3 DVD Package

Building a Defense for Youth Football
DVD #322195 : 25 min. **\$29**

Building an Offense for Youth Football
DVD #322196 : 57 min. **\$29**

Practice Organization and Drills for Youth Football
DVD#322197 : 36 min. **\$29**

\$79
322198



BFS Clinics Exercise Instruction \$29

Our Best Selling DVD

#322182



Includes instruction on:

- Squat
- Bench
- Glute Ham Developer
- Box Squat
- Towel Bench
- Power Clean
- Hex Bar Dead Lift
- Straight Leg Dead Lift

- Lunges
- Power Balance Drills
- Power Clean Drills



BFS Total Program



\$49
DVD-#322187
186 Minutes
2 DVDs

Complete Instructions
How to Record Lifts
All Core Lifts
Agility-Dot Drill, Flexibility
Speed & Plyos
In Short - Everything!

BFS Instruction Videos only \$29 each or 4 for \$99!

CORE/AUXILIARY LIFTS

THE SQUAT & VARIATIONS
DVD #322135 : 52 min.

POWER CLEAN
DVD #322136 : 57 min.

BENCH & VARIATIONS
DVD #322137 : 28 min.

DEADLIFT INSTRUCTION
DVD #322138 : 25 min.

AUXILIARY LIFTS
DVD #322140 : 37 min.

BFS PROGRAM

TOTAL PROGRAM WOMEN
DVD #322180 : 58 min.

READINESS PROGRAM
DVD #322155 : 58 min.

SETS & REPS
DVD #322139 : 63 min.

IN-SEASON TRAINING
DVD #322141 : 39 min.

WEIGHT ROOM SAFETY
DVD #322178 : 24 min.

PLYOMETRICS & SPEED

DOT DRILL
DVD #322160 : 25 min.

PLYO BOX JUMPING
DVD #322146 : 57 min.

SPEED WITH STEFAN
DVD #322145 : 36 min.

SPEED FOR ATHLETES
DVD #322144 : 39 min.

FLEXIBILITY
DVD #322151 : 22 min.

Nellie
★★★★★
"Powerful!"

How one mans struggle helps boys become men. Nellie is an inspiring, handicapped, young man who changes the hearts and minds of the hundreds of young people he serves. His deep Christian beliefs help him and others at Pacific Lutheran University, WA.

\$29
DVD-#322169
28 Minutes
Winner of over 20 awards

BFS Baseball Total Program 5 DVD Set ON SALE

This 5 DVD Set Includes:

FREE BONUS: BFS Baseball Strength Training DVD

BFSB Hitting DVD \$29.95 322184H

BFSB Catching DVD \$29.95 322184C

BFSB Pitching DVD \$29.95 322184P

BFSB Fielding DVD \$29.95 322184F

5 DVD SET!

\$69.95
322184



All BFS poster & chart sets are printed on 22" x 28" extra-thick, glossy, stock.

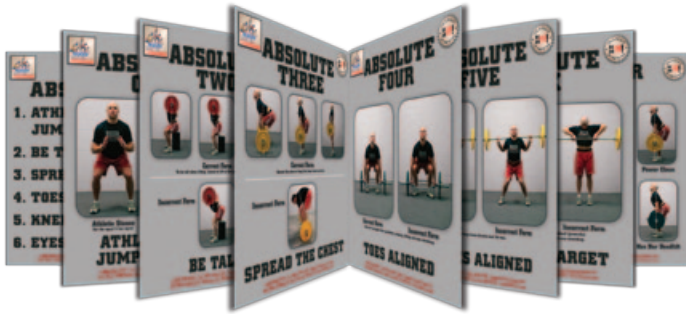

Six Absolutes Posters

8 Poster Set

► Teach perfect sport and lifting technique with the all-new, BFS Six Absolutes Posters!

\$80
#325036

Record Charts

\$40
#325025



Bench, Squat, Clean, Dead lift. Room for 70 athletes



Training Posters

5 Poster Set

- Squat
- Bench Press
- Power Clean
- Quick Lifts
- Hex Bar/Dead Lift

\$50
#325080

Speed & Plyo

\$50
#325026



Total Ranking, Dot Drill, 20 yd Speed, 40 yd Speed, V.J. & Long Jump



Safety Posters

3 Poster Set

- Knee Safety
- Hamstring Safety
- Back Safety

\$30
#325032

WEIGHT ROOM RULES

- WEAR PROPER WORKOUT ATTIRE - NO SANDALS**
- NO HORSEPLAY; LOUD, OFFENSIVE LANGUAGE; OR SPITTING**
- USE THE BFS SIX ABSOLUTES OF PERFECT TECHNIQUE WHEN LIFTING**
- USE COLLARS ON BARBELLS AND PROPERLY USE SAFETY PINS ON MACHINES**
- WHEN IN DOUBT, SEEK PROPER INSTRUCTION**
- USE EQUIPMENT FOR ITS INTENDED USE - DO NOT MODIFY THE EQUIPMENT**
- USE SPOTTERS AND SAFETY RACKS**
- HELP AND ENCOURAGE EACH OTHER! MAKE YOUR TEAMMATES GREAT!**

BFS Dedicated to Helping Athletes Succeed Since 1976

Weight Room Rules Poster

14 Weight Room Rules. A must for every weight room!

\$12
#325028

WEIGHT CLASS	5'6" TO 5'7"		5'8" TO 5'9"		5'10" TO 5'11"		6'0" TO 6'1"	
	ALL AMERICAN	STATE	ALL AMERICAN	STATE	ALL AMERICAN	STATE	ALL AMERICAN	STATE
100 LB	4.25	4.50	5.00	5.25	5.75	6.00	6.50	6.75
125 LB	4.75	5.00	5.50	5.75	6.25	6.50	7.00	7.25
150 LB	5.25	5.50	6.00	6.25	6.75	7.00	7.50	7.75
175 LB	5.75	6.00	6.50	6.75	7.25	7.50	8.00	8.25
200 LB	6.25	6.50	7.00	7.25	7.75	8.00	8.50	8.75
225 LB	6.75	7.00	7.50	7.75	8.25	8.50	9.00	9.25
250 LB	7.25	7.50	8.00	8.25	8.75	9.00	9.50	9.75
275 LB	7.75	8.00	8.50	8.75	9.25	9.50	10.00	10.25
300 LB	8.25	8.50	9.00	9.25	9.75	10.00	10.50	10.75
325 LB	8.75	9.00	9.50	9.75	10.25	10.50	11.00	11.25
350 LB	9.25	9.50	10.00	10.25	10.75	11.00	11.50	11.75
375 LB	9.75	10.00	10.50	10.75	11.25	11.50	12.00	12.25
400 LB	10.25	10.50	11.00	11.25	11.75	12.00	12.50	12.75
425 LB	10.75	11.00	11.50	11.75	12.25	12.50	13.00	13.25
450 LB	11.25	11.50	12.00	12.25	12.75	13.00	13.50	13.75
475 LB	11.75	12.00	12.50	12.75	13.25	13.50	14.00	14.25
500 LB	12.25	12.50	13.00	13.25	13.75	14.00	14.50	14.75

BFS Standards 4 Poster Set

Standards for Men & Women Strength, Standards for Men & Women Speed, & Jumping

\$40
#325070



BFS CLOTHING IS ONLINE

CLOTHING LINE

Get fit and get fitted out with the all new BFS Clothing Line. Available exclusively on biggerfasterstronger.com we have just what you need.

Training to Game Day - Athletes to Coaches.

With a full line of shirts and shorts in performance materials you will find the gear to help you achieve your goals in comfort and style. For Coaches we have khakis, polos and jackets to keep you steaming towards victory. From Golf to Football to Track - BFS is your solution to training in comfort so you can concentrate on results.

Certified Clothing line also available.

BFS Camps and Clinics

We are making it easier than ever to combine all the services and options BFS provides in a plan that makes sense for your unique situation. So whether you are looking for a 2-day exercise instruction clinic for your athletes, WRSC certification for your coaches, or all of the above, including a character building Be An 11 Seminar, we have a solution for you. See pages 4-9.

Weight Room Safety Certification

Every teacher and coach that works with students and athletes in a weight room is assuming some level of liability for the safety and success of their students. A WRSC prepares teachers and coaches with a winning fundamental program of weight lifting techniques and protocols. Through the hands-on training required for this certification coaches will help students and athletes achieve the strength and performance gains they are looking for in a setting that emphasizes perfect form and technique. Visit page 8 for more information on attending a WRSC in your region or hosting one for your school or facility.

2015 Catalog • 1-800-628-9737 • Fax (801) 975-1159 • www.biggerfasterstronger.com • info@bfsmail.com

PRSR STD
U.S. POSTAGE
PAID
Bigger Faster Stronger

keycode

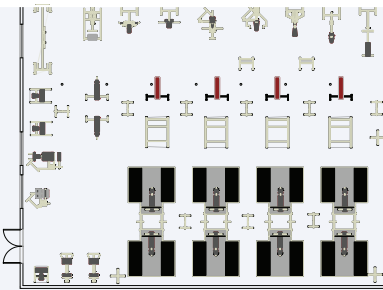

Don't miss - BFS Design Services from Concept to Completion - pg 3